



NEED HELP?
SCAN OR CLICK HERE
TO CONTACT US



Air-Met Scientific
www.airmet.com.au

Product Manual

*The Essential Guide for
Safety Teams and
Workers*

Edition: 4

November 15, 2023

Part Number: 17160218-1

INDUSTRIAL
SCIENTIFIC

Industrial Scientific Corporation, Pittsburgh, PA USA

Industrial Scientific Co., Ltd. Shanghai, China

© 2021, 2023 Industrial Scientific Corporation

All rights reserved. Published 2023.

Revision 3

www.indsci.com/tango-tx2

Contents

General Information	1
Certifications	1
Warnings and Cautionary Statements	2
Getting Started	3
Gas Monitoring and Sensors	3
User Interface (UI)	4
Gas-reading display behavior	4
Preparing the Tango TX2 for First Use	4
Using the Tango TX2	5
Power On and Start-up	5
General Operation	5
Alarms, Warnings, and Notifications	6
Wearing the Instrument	8
Maintenance Recommendations	8
Features and Settings	11
Overview	11
Settings Topics	11
Administrative features	12
Gas-alarm features	12
Worker-access features	13
Maintenance features	13
Settings-mode Access	14
Settings-mode UI	14
Specifications and Compatibilities	23
Instrument	23
Sensors	24
Power	29
Dock	29
Maintenance	31
Docking Station for Maintenance	31
Manual Processes for Maintenance	31
Process At-a-glance	31
Cleaning the Instrument Exterior	35
Service and Warranty	37
Service	37
Supplies	37
Tango TX2 illustrated	37
Service tasks	40

Warranty Policy.....	44
Limitation of Liability.....	44
Appendix A.....	45
Maintenance Definitions.....	45
Bump Test (or "functional test").....	45
Zero.....	45
Calibration.....	45
Appendix B.....	46
Supplemental Information about Sensors and Gases.....	46
Appendix C.....	47
Marking Requirements.....	47
Contact Information.....	48

Tables and Figures

Table 1.1 Hazardous-area certifications	1
Table 1.2 Warnings and cautionary statements.....	2
Table 2.1 Compatible gas sensors	3
Figure 2.1 User interface	4
Figure 3.1 Worker accessible options.....	6
Figure 3.2 Alarms and their related display symbols	7
Figure 3.3 Warnings and their related display symbols	8
Table 3.1 Recommended frequency for instrument maintenance	8
Table 4.1 Administrative features and related settings	12
Table 4.2 Gas-alarm features and related settings.....	12
Table 4.3 Worker-access features and related settings.....	13
Table 4.4 Maintenance features and related settings	13
Figure 4.1 Settings display-screen sample	14
Figure 4.2 Settings menu	14
Table 5.1 Instrument specifications	23
Table 5.2 Sensor specifications, Carbon Monoxide.....	24
Table 5.3 Sensor specifications, Carbon Monoxide with low Hydrogen cross-sensitivity	25
Table 5.4 Sensor specifications, Hydrogen Sulfide	26
Table 5.5 Sensor specifications, Nitrogen Dioxide	27
Table 5.6 Sensor specifications, Sulfur Dioxide.....	28
Table 5.7 Battery properties.....	29
Figure 6.1 Instruction for manually performed maintenance.....	32
Illustration 7.1 Disassembled Tango TX2 and case-top assembly	38
Table 7.1 Tango TX2 parts list.....	39
Table B.1 Sensor cross-sensitivity guidelines (percent response)	46
Table C.1 ATEX and IECEx marking requirements	47

General Information

Certifications

Warnings and Cautionary Statements

Certifications

Certifications for the Tango® TX2, at the time of this document's publication, are listed below.

To determine the hazardous-area classifications for which a particular instrument is certified, refer to its label or the instrument order.

Table 1.1 Hazardous-area certifications

Directive or CB	Area Classification	Standards
ATEX ^a	Ex ia I Ma	EN 60079-0: 2012
	Ex ia IIC T4 Ga	EN 60079-11: 2012
	Equipment Group and Category: I M1 and II 1G	EN 50303: 2000
China CPA	Metrology Pattern Approval	JJF 1363-2019
		JJF 1364-2012
		JJF 1421-2013
		Q310115000698C001
China Ex ^d	Ex ia IIC T4 Ga	GB 3836.1-2020
		GB 3836.4-2010
		GB3836.20-2010
IECEX ^b	Ex ia I Ma	IEC 60079-0: 2011
	Ex ia IIC T4 Ga	IEC 60079-11: 2011
UKEx ^c UL22UKEX2641	Ex ia I Ma	-40 °C to +50 °C (-40 °F to +122 °F)
	Ex ia IIC T4 Ga Equipment Group and Category: I M1 and II 1G	
UL (C-US) ^d	Class I, Groups A, B, C, and D; Class II, Groups E, F, and G; T4; Ex ia Class I, Zone 0, AEx ia IIC T4	UL 913 8th Ed.
		UL 60079-0 6th Ed.
		UL 60079-11 6th Ed.
		CSA C22.2 No. 157

^aThe EC type examination certificate is DEMKO 12 ATEX 1209126 with marking code Ex ia I Ma and Ex ia IIC T4 Ga for equipment group and category II 1G and I M1.

^aThe TANGO TX2 complies with relevant provisions of European ATEX directive 2014/34/EU and EMC directive 2014/30/EU.

^aThe TANGO TX2 is constructed with reference to published standards of LVD directive 2014/35/EU, to eliminate electrical risks and fulfill 1.2.7 of ANNEX II of directive 2014/34/EU.

^bThe IECEx examination certificate is IECEx UL 12.0041 with marking code Ex ia IIC T4 Ga and Ex ia I Ma for hazardous locations with an ambient temperature range of $-40\text{ °C} \leq T_a \leq +50\text{ °C}$ ($-40\text{ °F} \leq T_a \leq 122\text{ °F}$).

^cThe TANGO TX2 complies with relevant provisions of harmonized standards and legislation for UK SI 2016 No. 1107, No. 1091, UK SI 2012 No. 3032.

^dThe TANGO TX2 is UL certified according to the National Electrical Code and Canadian Electrical Code for use in Class I, Division 1 hazardous locations with an ambient temperature range of $-40\text{ °C} \leq T_a \leq +50\text{ °C}$ ($-40\text{ °F} \leq T_a \leq 122\text{ °F}$).

^dThe marking code of the China Ex examination certificate is Ex ia IIC T4 Ga for hazardous locations with an ambient temperature range of $-40\text{ °C} \leq T_a \leq +50\text{ °C}$ ($-40\text{ °F} \leq T_a \leq 122\text{ °F}$).

Note: See also [Marking Requirements](#) for ATEX and IECEx.

Warnings and Cautionary Statements

IMPORTANT: Read and understand this Product Manual before operating the instrument.

Table 1.2 Warnings and cautionary statements



For maximum safety and optimal performance, read and understand the manual before operating or servicing the unit. Failure to perform certain procedures or note certain conditions may impair the performance of this product.



For safety reasons, this equipment must be operated and serviced by qualified personnel only.



Substitution of components may impair intrinsic safety and may cause an unsafe condition.



Do not replace battery in hazardous locations. Only certified for use with one (1) Tadiran TL-5955 battery cell.



Sensor openings and water barriers must be kept clean. Obstruction of the sensor openings or contamination of the water barriers may cause readings to be lower than actual gas concentrations.



Service the unit, use its communication port, and change its battery cell only in nonhazardous locations. Not for use in oxygen-enriched atmospheres.



Contact your service representative immediately if you suspect that the unit is working abnormally.

Getting Started

Gas Monitoring and Sensors

User Interface (UI)

Preparing the Tango TX2 for First Use

Gas Monitoring and Sensors

Measuring gas at two-second intervals, the Tango® TX2 is a portable, two-gas diffusion monitor (instrument) for personal protection. See [“Instrument specifications”](#).

Tango TX2 is compatible with the Industrial Scientific sensors listed below and supports *only* a two-sensor configuration. The instrument does *not* support a single-sensor configuration.

Sensors are customer replaceable. To install new or replacement sensors, see [“Sensor replacement”](#).

Table 2.1 Compatible gas sensors

Gas sensor	Display screen symbol	Part number	Details
Carbon Monoxide (CO)	CO	17160204	specifications
Carbon Monoxide with low Hydrogen cross-sensitivity (CO/H ₂ Low)	CO _L	17160208	specifications
Hydrogen Sulfide (H ₂ S)	H ₂ S	17160207	specifications
Nitrogen Dioxide (NO ₂)	NO ₂	17160205	specifications
Sulfur Dioxide (SO ₂)	SO ₂	17160206	specifications



Data are saved every ten seconds and stored to the instrument data log. The data log has these characteristics:

- Capacity for approximately three months of data for a unit that is on 24 hours a day.
- Date- and time-stamped entries for 60 alarm events, 30 error events, and up to 250 manual calibration procedures and bump tests.
- As new data are logged to memory, the oldest data are overwritten.
- Downloaded on docking in a compatible docking station from Industrial Scientific.

User Interface (UI)

As illustrated below, Tango TX2 UI comprises instrument buttons, lights, sounds, and vibration along with display-screen characters and symbols. The home-screen illustration indicates how gas readings generally appear during operation. Likewise, the alarm-screen example shows how the display generally appears when a gas event has caused an instrument alarm; sound, light, and vibration signals would also occur based on the alarm type and some settings.

Figure 2.1 User interface

Instrument	Display screen (samples)
 <p>Lights</p> <p>Power button</p> <p>Speaker</p> <p>Enter button</p> <p>Display screen</p> <p>Vibration (not shown)</p>	<p>Home screen</p> <div style="border: 1px solid black; padding: 5px; display: inline-block;">  </div> <ul style="list-style-type: none"> ✓ Operating H2S Gas sensor 5.1 PPM Gas reading and unit of measure <hr style="border-top: 1px dashed black;"/> <p>Alarm screen</p> <div style="border: 1px solid black; padding: 5px; display: inline-block;">  </div> <ul style="list-style-type: none"> ✓ Operating High alarm H2S Alarm-causing gas sensor 20.0 PPM Gas reading and unit of measure

Gas-reading display behavior

The safety team sets how the instrument—when *not* in alarm—will display gas readings. As noted in the setting, “Gas reading display”, the options are:

- Display readings only for sensor 1.
- Display readings only for sensor 2.
- Alternately display readings for one sensor, then the other using a 3-second interval.

When a gas sensor causes an instrument alarm, the instrument will automatically display gas readings using the alternating pattern. When the alarm-causing condition is no longer detected, the readings display will revert to its set behavior.

Preparing the Tango TX2 for First Use

There are three steps to prepare the Tango TX2 for first use.

1. Review instrument settings and adjust as needed. See the chapter, [“Features and Settings.”](#)
2. Calibrate the instrument. See the chapter, [“Maintenance”](#).
3. Perform a bump test. See the chapter, [“Maintenance”](#).

Using the Tango TX2

Power On and Start-up

General Operation

Alarms, Warnings, and Notifications

Wearing the Instrument

Maintenance Recommendations

Power On and Start-up

To power on the instrument, press and hold the power button (🔌) for three seconds, then release.

During start-up, if any diagnostics fail, an error will display; otherwise, all the audio, visual, and vibration indicators will turn on then off. This will be followed by a series of display screens, which based on settings, can include any of the following:

- Visual test screen
- Version information
- Calibration date information
- Calibration gas settings
- Gas alert settings
- Low alarm gas settings
- High alarm gas settings
- TWA alarm settings
- STEL alarm settings
- Gas readings (home screen)

The instrument indicates through an audible beep when it is ready for normal operation.



General Operation

During operation use the buttons as follows:

- To scroll from display to display, repeatedly press power (🔌).
- To perform a displayed task or maintenance option, press enter (↵).

Depending on settings, workers may have access to any of the information and options presented in [Figure 3.1](#).

Figure 3.1 Worker accessible options

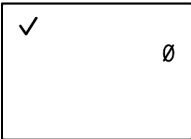
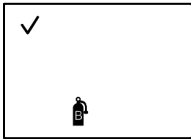
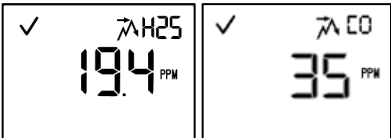
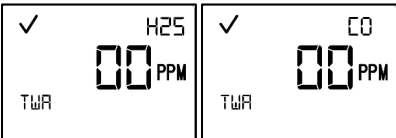
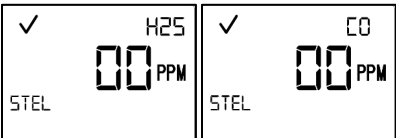
Display screen	Information and options
	Time of day; 24-hour clock used.
	Calibration due information; format shown here is <i>next</i> calibration date (▲).
	Optionally start the zero-calibration process (Ⓢ).
	Optionally start a bump test (Ⓢ).
	View peak readings; optionally clear and reset the reading (Ⓢ).
	View TWA readings; optionally clear a TWA reading, which also resets its time interval (Ⓢ).
	View STEL readings; optionally clear a STEL reading, which also resets its time interval (Ⓢ).

Alarms, Warnings, and Notifications













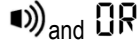
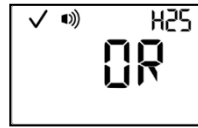

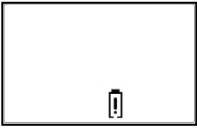

Different events can produce the same or similar light, noise, or vibration patterns. For example, a high alarm pattern can signal a dangerously high gas reading, a critically low battery, or another event. Each unique event is distinguished by the symbols and characters on the display screen.

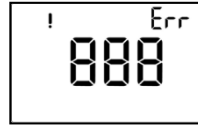
Take seriously all alarms, warnings, and notifications, and respond according to company policy.

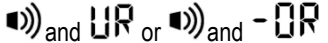
Alarms

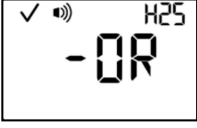
Alarms notify the worker of danger. The *high alarm* is fast in pace with red lights and steady sound. By comparison, the *low alarm* is slower with blue lights, red lights, and steady sound. Alarms persist until the alarm-causing condition is no longer detected.

Figure 3.2 Alarms and their related display symbols

High-alarm events		
 High-alarm gas 	 Over-range gas 	 STEL 
 Critical low battery 	 System error (888) ^a 	 Sensor failure 
 Under-range or negative over-range  	— 	—
Low-alarm events		
 Low-alarm gas 	 TWA 	—

^aVariations: 483 for sensor error; 408 for no sensor installed.









Warnings

Warnings notify the worker of a condition that needs attention.

Some warnings precede a related alarm. For example, a low-battery *warning* occurs before the critical low-battery *alarm*.

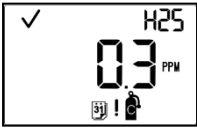
Warnings turn on and off repeatedly. The more urgent the warning, the shorter the time between on-off occurrences; i.e., a warning that repeats every two seconds is more urgent than a warning that repeats every 30 seconds. Warnings persist until the causing issue is resolved.

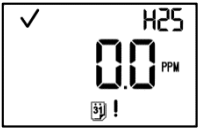
Figure 3.3 Warnings and their related display symbols

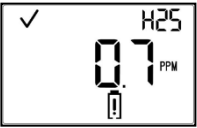
Calibration due	Bump test due	Dock due	Gas alert	Low battery
				
				

Notifications

Indicators notify of a status. Each occurs at a regular frequency and at a pace that is slower than a warning or alarm. For example, a confidence indicator can be enabled to occur every 60 seconds to flash a blue light, emit a chirp, or both.

Wearing the Instrument

Based on the U.S. Department of Labor's Occupational Safety and Health Administration (OSHA), it is recommended that the instrument be worn within a 25.4 cm (10") radius of the breathing zone. Use this information in combination with company safety policy and applicable directives or recommendations from relevant regulatory and other groups.

Maintenance Recommendations

Provided below are Industrial Scientific minimum-frequency recommendations for maintenance procedures.

These recommendations support instrument performance and are based on field data, safe work procedures, industry best practices, and regulatory standards. Use them in combination with company safety policy, applicable directives and recommendations of regulatory groups, environmental conditions, operating conditions, instrument use patterns and exposure to gas, and other factors.

For maintenance instructions, see the chapter, "[Maintenance.](#)"

For definitions of key procedures, see "[Appendix A, Maintenance Definitions.](#)"

Table 3.1 Recommended frequency for instrument maintenance

Procedure	Recommended minimum frequency
Settings	Before first use, when an installed sensor is replaced, and as needed.
Calibration ^a	Before first use and monthly thereafter.

Table 3.1 Recommended frequency for instrument maintenance

Procedure	Recommended minimum frequency
Bump test	Before first use and prior to each day's use thereafter.
Docking	When a dock due warning occurs and as needed for periodic maintenance and upgrades from Industrial Scientific.
Exterior case cleaning	As needed.
Self-test ^b	—

^aBetween regular calibration procedures, Industrial Scientific also recommends calibration immediately following each of these occurrences: the installation of a new (or replacement) sensor; the unit falls, is dropped, or experiences another significant impact; is exposed to water; fails a bump test; has been exposed to an over-range (positive or negative[under-range]) gas concentration.

^bThe instrument performs a self-test during power on. If set to always-on, the instrument will perform a self-test every 24 hours. The self-test can be completed on demand by the worker.

Note: The use of calibration gases not provided by Industrial Scientific may void product warranties and limit potential liability claims.

Features and Settings

Overview

Settings Topics

Settings-mode Access

Setting-mode

Overview

Use Tango® TX2 features and their related settings to support your company's safety policy and to shape in-field worker experience with the instrument.

When working in settings mode, apply the guidelines stated below.

- Only qualified, safety-team personnel should access the instrument's settings mode and adjust settings.
- Consider the air-sampling environment to help you make good setting choices.
- Be knowledgeable of company policies as they apply to setting choices.
- As issued by regulatory agencies and government or industry groups, be knowledgeable of regulations, laws, and guidelines for their effects on setting choices.

IMPORTANT: Settings that can be adjusted manually through the instrument are described in this chapter; these and other settings can also be adjusted through iNet® Control. Any setting changes made manually to the instrument will be overridden when the instrument is docked.

Settings Topics

You can read about instrument features as grouped in the four topics listed below. Each topic provides some information about *why* you might want to use certain features, providing reference to related settings.

- administrative
- gas alarms
- worker access
- maintenance

Alternately, you can skip to [instruction](#) for *how to* access and work in settings mode. [Figure 4.2 Settings menu](#) lists settings in the order you will encounter them and provides details about the available options.

Administrative features

Use administrative features to set readability aspects of the worker’s display screen, along with security, support for data-log integrity, and other general features.

Table 4.1 Administrative features and related settings

Feature	Related settings
Determine the gas-reading format a worker will see on the display screen. With numeric format, the worker to see the reading and with text, a notation (e.g. OK).	Display style (numeric or text) Language Deadband
Use a valid security code to restrict worker access to settings mode, guarding against unintended changes to instrument settings. A security code also supports always-on functionality. Prevent (or permit) worker ability to power off the instrument when it is in alarm.	Security code Always on Shutdown in alarm
For in-field confidence a worker is instrument equipped, make use of the visual-audible indicator.	Confidence indicator
Support data-log accuracy with correct date and time settings.	Date Time

Gas-alarm features

Set the gas-concentration readings that will cause gas alerts, warnings, and alarms. Optionally use features to latch instrument alarms and set functionality for TWA and STEL.

Table 4.2 Gas-alarm features and related settings

Feature	Related settings
Set the minimum gas-concentration reading required to signal workers of these alarms: <ul style="list-style-type: none"> low-alarm gas event high-alarm gas event Alternately, set low-alarm and high-alarm values based on country or world region. <i>Note:</i> Because these alarms can be edited separately <i>and</i> through the country-of-origin, the instrument applies this over-ride: the last saved setting over-rides previous settings.	Low-alarm gas setting High-alarm gas setting Alternately, Country of origin
Use (or don't use) the optional gas-alert feature. If used, set the minimum gas-concentration reading required to alert the worker of readings that may be approaching alarm level.	Gas alert feature Gas alert setting
Use (or don't use) the instrument's optional STEL and TWA features. If used, set the minimum sum of gas required to alarm the worker.	TWA and STEL multi-option STEL alarm setting TWA alarm setting
Use the optional alarm latch to sustain alarm signals until they are manually turned off by the worker.	Alarm latch

Table 4.2 Gas-alarm features and related settings

Feature	Related settings
Use the optional vibration alarm signals, which can be helpful in noisy environments.	Vibration alarm

Worker-access features

Set worker accessibility for operation-mode options (e.g., clear peak readings). Set warnings to notify workers of maintenance due such as docking.

Table 4.3 Worker-access features and related settings

Feature	Related settings
If the optional STEL or TWA feature is set for operation, their readings can be set for worker visibility and reset.	Operation-mode TWA Operation-mode STEL
There are three optional maintenance warnings that are used to notify the worker about needed maintenance (e.g., calibration). Functionality and signal type are separately set for <i>each</i> warning. Enabled maintenance warnings share a single setting for warning interval (e.g., every 30 minutes).	Bump-test-due warning Calibration-due warning Dock-due warning Maintenance warning interval
Workers can be given or denied operation-mode access to manually perform maintenance. Worker access is separately set for each task: bump test, zero, or calibration.	Operation-mode bump test Operation-mode zero Operation-mode calibration
Set the display style for calibration-date information (next or last).	Calibration date

Maintenance features

Use these features to define the instrument’s maintenance routine, supporting instrument health and maintenance-due warnings for workers.

Table 4.4 Maintenance features and related settings

Feature	Related settings
Set the dock-due interval to support regular synchronization with iNet and download of instrument enhancements from Industrial Scientific.	Dock-due interval
Set the instrument to alarm or not alarm while docked.	Alarms while docked
Set these bump test parameters: The <i>interval</i> at which the instrument is to be bump tested. The <i>percentage</i> of calibration gas the instrument must read for a bump test. The <i>response time</i> needed for a bump test—the number of seconds within which the sensor will respond to the calibration gas.	Bump test interval Bump test percentage Bump test response time
Set these zero and calibration parameters: The <i>interval</i> at which the instrument is to be calibrated. The <i>gas type</i> and <i>concentration</i> needed for calibration.	Calibration due interval Calibration gas

Settings-mode Access

To access settings mode, power on the instrument and during startup:

1. Press and hold both buttons (⏻ and ⏪) at the same time.
2. If the unit is security-code protected, you will be prompted to edit (Ⓢ) the value to match the three-digit code; then, press ⏻. When in settings, the LED on Tango starts flashing.

Settings-mode UI

The settings-mode screenshot shown below displays the tool symbol (⌘), which indicates the instrument is in settings mode. The remaining UI elements indicate a *high alarm* is set to occur when the H_2S gas reading reaches 20.0 ppm or higher.

Figure 4.1 Settings display-screen sample

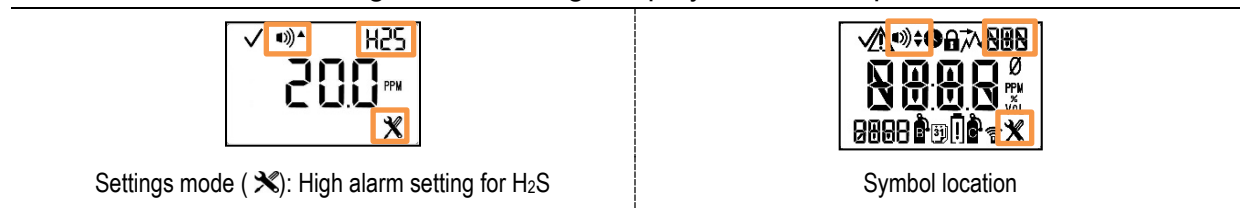

You will encounter each setting in the order shown [Figure 4.2](#). To scroll the menu, repeatedly press the power button (⏻). When you want to change a setting, use the buttons as follows:

- ⏪ Press until the desired setting option displays.
- ⏻ Press to save the setting.

IMPORTANT: When you set something to “disabled”, it will *not* be operational.

If more than 30 seconds pass after a button is pressed, settings mode is exited. If this occurs, simply power off the instrument; then, power on and access settings during startup.

Figure 4.2 Settings menu

Display screen	Setting and options
	Initiate zero Optionally zero the sensors (Ⓢ).
	Low-alarm gas setting (H_2S shown) Choose (Ⓢ) the minimum gas-reading concentration that will cause a low alarm for the displayed gas type (H_2S shown here). Save (⏻) the setting. You will be prompted to repeat the same setting sequence but for the other installed gas sensor. Value parameters: <ul style="list-style-type: none"> • within the sensor’s measurement range • higher than the sensor’s <i>gas-alert</i> setting • lower than the sensors <i>high-alarm</i> gas setting

Figure 4.2 Settings menu

Display screen	Setting and options
	<p>High-alarm gas setting (H₂S shown)</p> <p>Choose (⊕) the minimum gas-reading concentration that will cause a high-alarm for the displayed gas type (H₂S shown here). Save (⊕) the setting. You will be prompted to repeat the same setting sequence but for the other installed gas sensor.</p> <p>Value parameters:</p> <ul style="list-style-type: none"> • within the sensor's measurement range • higher than the sensor's <i>gas alert</i> and <i>low-alarm</i> settings
	<p>Gas-alert setting</p> <p>Choose (⊕) the minimum gas-reading concentration that will cause a gas alert for the displayed gas type (H₂S shown here). Save (⊕) the setting. You will be prompted to repeat the same setting sequence but for the other installed gas sensor.</p> <p>Value parameters:</p> <ul style="list-style-type: none"> • within the sensor's measurement range • lower than sensor's low-alarm gas setting
	<p>TWA and STEL multi-option</p> <p>Choose (⊕) the option to enable or disable each feature. A disabled feature will <i>not</i> be functional.</p> <p>0 = Both TWA and STEL enabled 1 = TWA enabled; STEL disabled 2 = STEL enabled; TWA disabled 3 = Both disabled</p> <p>Save (⊕) the setting.</p>
	<p>Gas reading display</p> <p>Set (⊕) gas readings to separately display for each sensor, alternating every 3 seconds; otherwise, set the display readings for <i>only one</i> of the installed sensors.</p> <p>0 = Only display sensor 1 readings 1 = Only display sensor 2 readings 2 = Alternately display sensor 1 and sensor 2 readings</p> <p>Save (⊕) the setting.</p>
	<p>Calibration due shutdown</p> <p>Choose (⊕) to enable or disable the option for calibration due shutdown.</p> <p>When enabled, the instrument will automatically shut down when the calibration is due.</p> <p>Values:</p> <p>0 = disabled 1 = enabled</p> <p>Save (⊕) the setting.</p>

Figure 4.2 Settings menu



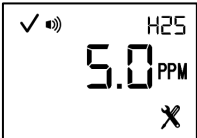
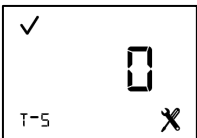
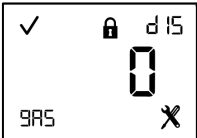
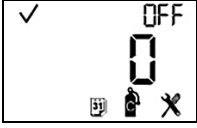

Display screen	Setting and options
	<p>Calibration type</p> <p>Set (⊕) the instrument for “quick” calibration when only one blended-gas cylinder will be used to bump test or calibrate both sensors. Use the “standard” setting when more than one gas cylinder is needed; this process allows the user time to change cylinders.</p> <p>0 = standard 1 = quick</p> <p>Save (⊕) the setting.</p>
	<p>Operation-mode TWA</p> <p>Use (⊕) a setting of “enabled” to allow workers and other users to view and optionally reset TWA readings from operation mode; otherwise, choose disabled.</p> <p>0 = disabled 1 = enabled</p> <p>Save (⊕) the setting.</p>
	<p>TWA alarm setting</p> <p>Choose (⊕) the minimum cumulative gas measure that will cause a TWA alarm (H2S shown here). Save the setting (⊕). You will be prompted to repeat the same setting sequence but for the other installed gas sensor.</p>
	<p>TWA time base</p> <p>Choose (⊕) the number of hours over which TWA readings will accumulate.</p> <p>Value range: 1 to 40 hours</p> <p>Save (⊕) the setting.</p>
	<p>Operation-mode STEL</p> <p>Use (⊕) a setting of “enabled” to allow workers and other users to view and optionally reset STEL readings from operation mode; otherwise, choose disabled.</p> <p>0 = disabled 1 = enabled</p> <p>Save (⊕) the setting.</p>
	<p>STEL alarm setting</p> <p>Choose (⊕) the minimum cumulative gas measure that will cause a STEL alarm (H2S shown here). Save the setting (⊕). You will be prompted to repeat the sequence but for the other installed gas sensor.</p>
	<p>Calibration gas</p> <p>Choose (⊕) calibration-gas concentration the instrument should expect to read when calibrated; the gas cylinder's corresponding concentration should match. Save (⊕) the setting. You will be</p>

Figure 4.2 Settings menu

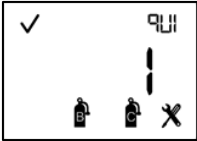
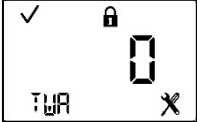

Display screen	Setting and options
	<p>prompted to repeat the sequence but for the other installed gas sensor.</p> <p>Time</p> <p>The clock uses a 24-hour format. You will be prompted to set (⌚) the hour; save (⌚) the setting. You will be prompted to repeat the sequence to set minutes.</p> <p>Hours: 00 to 24 Minutes: 00 to 59</p>
	<p>Date</p> <p>You will be prompted to set (⌚) the year; save (⌚) the setting. You will be prompted to repeat the sequence for day and again for month.</p> <p>Year: 20XX to 2099, where XX = current year Day: 00 to 31 Month: 00 to 12</p>
	<p>Display style</p> <p>Use (⌚) a setting of numeric if the worker is to see actual gas readings; a text setting will display something like "OK" in place of the numeric reading.</p> <p>0 = numeric display 1 = text display</p> <p>Save (⌚) the setting.</p>
	<p>Confidence indicator</p> <p>Use (⌚) a setting of "enabled" for the instrument to emit the desired signal or signals every 60 seconds; otherwise, choose disabled.</p> <p>0 = disabled 1 = enabled for audible chirp 2 = enabled for blue lights 3 = enabled for audible chirp and blue lights</p> <p>Save (⌚) the setting.</p>
	<p>Operation-mode bump test</p> <p>Use (⌚) a setting of "enabled" to allow workers and other users to bump test the gas sensors from operation mode; otherwise, choose disabled.</p> <p>0 = disabled 1 = enabled</p> <p>Save (⌚) the setting.</p>
	<p>Bump test due warning</p> <p>To warn the worker the instrument requires a bump test, choose (⌚) "enabled" for the desired signal; otherwise, choose disabled.</p> <p>0 = disabled 1 = enabled for audible chirp 2 = enabled for blue lights</p>

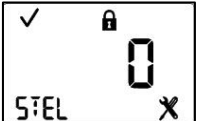
Figure 4.2 Settings menu

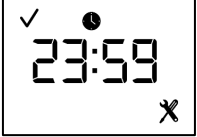
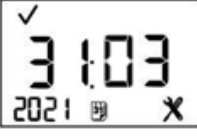
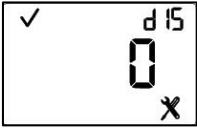
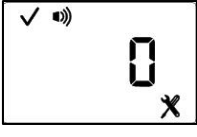
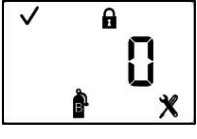

Display screen	Setting and options
	<p>3 = enabled for audible chirp and blue lights</p> <p>Save (Ⓢ) the setting.</p>
	<p>Bump test interval</p> <p>Choose (Ⓢ) interval at which the instrument is to be bump tested.</p> <p>Value range: 0.5 to 30.0 days</p> <p>Value increment: 0.5 days</p> <p>Save (Ⓢ) the setting.</p>
	<p>Bump test percentage</p> <p>Set (Ⓢ) the percentage of calibration gas to which the instrument will respond.</p> <p>Value range: 50% to 95%</p> <p>Value increment: 1%</p> <p>Save (Ⓢ) the setting.</p>
	<p>Bump test response time</p> <p>Set (Ⓢ) the amount of time needed for the sensor to respond to the calibration gas.</p> <p>Value range: 30 to 120 seconds</p> <p>Value increment: 1 second</p> <p>Save (Ⓢ) the setting.</p>
	<p>Alarm latch</p> <p>Use (Ⓢ) a setting of “enabled” if you want the instrument to remain in alarm until it is “unlatched” by the worker; otherwise, choose disabled.</p> <p><i>Note:</i> To unlatch an alarm, the worker presses (Ⓢ).</p> <p>0 = disabled</p> <p>1 = enabled</p> <p>Save (Ⓢ) the setting.</p>
	<p>Vibration alarm</p> <p>Use (Ⓢ) a setting of “enabled” if you want the instrument to vibrate during alarms; otherwise, choose disabled.</p> <p>0 = disabled</p> <p>1 = enabled</p> <p>Save (Ⓢ) the setting.</p>
	<p>Operation-mode zero</p> <p>Use (Ⓢ) a setting of “enabled” to allow all users to zero the gas sensors from operation mode; otherwise, choose disabled.</p> <p>0 = disabled</p> <p>1 = enabled</p> <p>Save (Ⓢ) the setting.</p>
	<p>Operation-mode calibration</p> <p>Use (Ⓢ) a setting of “enabled” to allow all users to calibrate the instrument operation mode; otherwise, choose disabled.</p> <p>0 = disabled</p>

Figure 4.2 Settings menu



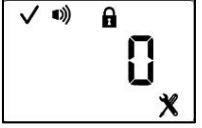
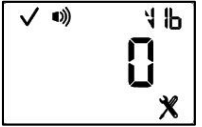
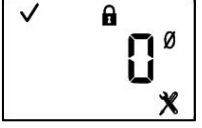
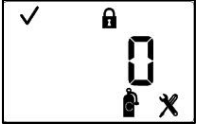

Display screen	Setting and options
	<p>1 = enabled</p> <p>Save (⊕) the setting.</p>
	<p>Calibration-due warning</p> <p>To warn the worker the instrument requires calibration, use (⊕) a setting of “enabled” for the desired signal; otherwise, choose disabled.</p> <p>0 = disabled</p> <p>1 = enabled for audible chirp</p> <p>2 = enabled for blue lights</p> <p>3 = enabled for audible chirp and blue lights</p> <p>Save (⊕) the setting.</p>
	<p>Calibration-due interval</p> <p>Set (⊕) the interval at which the instrument is to be calibrated.</p> <p>Value range: 1 to 365 days</p> <p>Value increment: 1 day</p> <p>Save (⊕) the setting.</p>
	<p>Calibration date</p> <p>Set (⊕) the display to indicate the instrument’s <i>next</i> calibration or <i>last</i> calibration.</p> <p>0 = last calibration</p> <p>1 = next calibration</p> <p>Save (⊕) the setting.</p>
	<p>Dock-due warning</p> <p>To warn the worker the instrument requires docking, use (⊕) a setting of “enabled” for the desired signal; otherwise, choose disabled.</p> <p>0 = disabled</p> <p>1 = enabled for audible chirp</p> <p>2 = enabled for blue lights</p> <p>3 = enabled for audible chirp and blue lights</p> <p>Save (⊕) the setting.</p>
	<p>Maintenance-warning interval (minutes)</p> <p>Set (⊕) the interval at which the worker will be warned of maintenance due (bump test, calibration, and dock due).</p> <p>Value range: 1 to 60 minutes</p> <p>Value increment: 1 minute</p> <p>Save (⊕) the setting.</p>
	<p>Security code</p> <p>If you want to <i>restrict</i> access to settings mode and to powering off an instrument that is set to “always-on”, set (⊕) the security code to something other than “000”.</p> <p>Value range: 001 to 999</p> <p>Value increment: 1</p> <p>Save (⊕) the setting.</p>

Figure 4.2 Settings menu

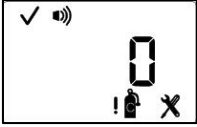

Display screen	Setting and options
	<p>Country of origin</p> <p>Use (Ⓢ) this setting to allow the instrument to apply predetermined low-alarm and high-alarm settings based on country (or region) of origin. Because these settings can be edited separately <i>and</i> through the country-of-origin, the instrument applies this override: the last saved setting overrides previous settings.</p> <ul style="list-style-type: none"> “DEF” for USA and default value “CA n” for Canada “EUR” for Europe “CR” for Czech Republic “AUS” for Australia <p>Save (Ⓢ) the setting.</p>
	<p>Language</p> <p>Set (Ⓢ) the display screen for one of the available languages.</p> <ul style="list-style-type: none"> “EN” for English “F” for French <p>Save (Ⓢ) the setting.</p>
	<p>Always on</p> <p>Set (Ⓢ) the instrument to always be on; otherwise, choose disabled.</p> <p><i>Note:</i> If the instrument has a valid security code, it can be used by the worker to power off an always-on instrument.</p> <ul style="list-style-type: none"> 0 = disabled 1 = enabled <p>Save (Ⓢ) the setting.</p>
	<p>Shutdown in alarm</p> <p>Use (Ⓢ) this setting to prevent the worker from shutting down the instrument when it is in alarm; otherwise, allow in-alarm shutdown.</p> <ul style="list-style-type: none"> 0 = prevent shutdown 1 = allow shutdown <p>Save (Ⓢ) the setting.</p>
	<p>Deadband</p> <p>Use (Ⓢ) this setting to display a gas reading of “0” (zero) when the detected gas concentration falls within a sensor’s deadband.</p> <ul style="list-style-type: none"> 0 = disabled; always display <i>actual</i> gas reading 1 = enabled; display <i>zero</i> when the detected gas concentration is within the deadband <p>Save (Ⓢ) the setting.</p>
	<p>Alarms when docked</p> <p>Use (Ⓢ) this setting to disable alarms when the instrument is docked; otherwise allow alarms to occur when docked.</p> <ul style="list-style-type: none"> 0 = alarms disabled while docked 1 = alarms can occur while docked <p>Save (Ⓢ) the setting.</p>

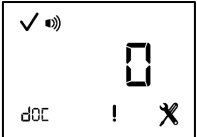
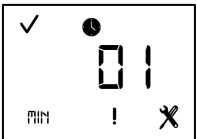
Figure 4.2 Settings menu

Display screen

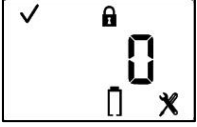
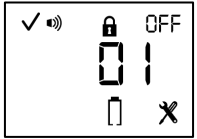
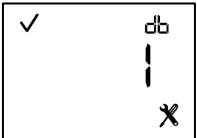
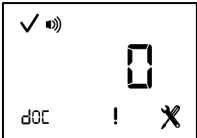
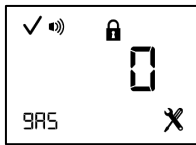

Setting and options

Gas alert function

Use (←) a setting of “enabled” to make gas alerts functional. Gas alerts notify the worker when a detected gas concentration may be approaching alarm levels.

0 = disabled

1 = enabled

Save (→) the setting.

Go (←) to the first setting.

Specifications and Compatibilities

Instrument

Sensors

Power

Dock

Instrument

Use the instrument specifications below to ensure the gas-monitoring or storage environments meet the stated conditions and to learn of other instrument properties.

Table 5.1 Instrument specifications
for Tango TX2

Item	Description
Display	Segment LCD
Keypad buttons	Two buttons
Case materials	Case top: polycarbonate with a protective rubber over-mold Case bottom: conductive polycarbonate
Alarms	Three strobe-emitting visual alarm LEDs (two red; one blue) 95 dB alarm; audible at a distance of 10 cm (3.94"), typical Vibration alarm
Dimensions	99 x 51 x 35 mm (3.9 " x 2.0 " x 1.4 ")
Weight	126 g (4.4 oz.), typical
Ingress protection	IP66 and IP67
Operating temperature range ^a	-20 °C to +50 °C (-4 °F to +122 °F)
Operating humidity range	15–90% relative humidity (RH) noncondensing (continuous)
Storage temperature range ^a	0 °C to +25 °C (32–77 °F)
Storage humidity range	40–70% RH noncondensing

^aTemperatures outside this range may cause reduced instrument accuracy and affect display and alarm performance.

Sensors

Specifications are provided for each sensor to help you understand the operating conditions it will tolerate and to be a decision-making reference for gas-related settings such as alarms and maintenance parameters.

Table 5.2 Sensor specifications, Carbon Monoxide
CO for Tango TX2; part number 17160204

Properties	
Category	Toxic
Technology	Electrochemical
Installation location	1 or 2
Operating conditions ^a	
Temperature range	-40 to +50 °C (-40 to +122 °F)
RH range	15-90%
Performance	
Sensitivity	
Measurement range ^c	0–1000 ppm
Measurement resolution	1 ppm
Accuracy ^b	
Calibration gas and concentration	100 ppm CO
Accuracy at time and temperature of calibration	± 5%
Accuracy over sensor's full temperature range	± 15%
Response Time	
T50	12 s
T90	20 s

^aDuring continuous operation.

^bApply when the instrument is calibrated using the stated calibration gas and concentration; accuracy is equal to the stated percentage or one unit of resolution, whichever is greater.

^cIf the device is exposed to concentrations higher than the measurement range, it would require a recalibration.

Note: See "[Appendix B](#)" for supplemental information about sensor types and gases.

Table 5.3 Sensor specifications, Carbon Monoxide with low Hydrogen cross-sensitivity
CO/H₂ Low for Tango TX2; part number 17160208

Properties	
Category	Toxic
Technology	Electrochemical
Installation location	1 or 2
Operating conditions ^a	
Temperature range	-20 to +50 °C (-4 to +122 °F)
RH range	15-95%
Performance	
Sensitivity	
Measurement range ^c	0–1000 ppm
Measurement resolution	1 ppm
Accuracy ^b	
Calibration gas and concentration	100 ppm CO
Accuracy at time and temperature of calibration	± 5% (0–300 ppm) ± 15% (301–1000 ppm)
Accuracy over sensor's full temperature range	± 15%
Response Time	
T50	9 s
T90	18 s

^aDuring continuous operation.

^bApply when the instrument is calibrated using the stated calibration gas and concentration; accuracy is equal to the stated percentage or one unit of resolution, whichever is greater.

^cIf the device is exposed to concentrations higher than the measurement range, it would require a recalibration.

Note: See "Appendix B" for supplemental information about sensor types and gases.

Table 5.4 Sensor specifications, Hydrogen Sulfide
H₂S for Tango TX2; part number 17160207

Properties	
Category	Toxic
Technology	Electrochemical
Installation location	
	1 or 2
Operating conditions ^a	
Temperature range	-40 to +50 °C (-40 to +122 °F)
RH range	15-90%
Performance	
Sensitivity	
Measurement range ^c	0–500 ppm
Measurement resolution	0.1 ppm
Lower limit	0.5 ppm
Accuracy ^b	
Calibration gas and concentration	25 ppm H ₂ S
Accuracy at time and temperature of calibration	± 5%
Accuracy over sensor's full temperature range	± 35% (-40 to -11 °C) ± 15% (-10 to 40 °C) ± 35% (41 to 50 °C)
Response Time	
T50	11 s
T90	19 s
Recovery Time	
T50	11 s
T10	18 s
Warmup Time	
	40 s
Time to Alarm	
-40 °C	≤ 23 s
-10 °C	≤ 16 s

^aDuring continuous operation.

^bApply when the instrument is calibrated using the stated calibration gas and concentration; accuracy is equal to the stated percentage or one unit of resolution, whichever is greater.

^cIf the device is exposed to concentrations higher than the measurement range, it would require a recalibration.

Note: See "Appendix B" for supplemental information about sensor types and gases.

Table 5.5 Sensor specifications, Nitrogen Dioxide
 NO₂ for Tango TX2; part number 17160205

Properties	
Category	Toxic
Technology	Electrochemical
Installation location	1 or 2
Operating conditions ^a	
Temperature range	-30 to +50 °C (-22 to +122 °F)
RH range	15-95%
Performance	
Sensitivity	
Measurement range ^c	0–150 ppm
Measurement resolution	0.1 ppm
Accuracy ^b	
Calibration gas and concentration	25 ppm NO ₂
Accuracy at time and temperature of calibration	± 10%
Accuracy over sensor's full temperature range	± 15%
Response Time	
T50	10 s
T90	30 s

^aDuring continuous operation.

^bApply when the instrument is calibrated using the stated calibration gas and concentration; accuracy is equal to the stated percentage or one unit of resolution, whichever is greater.

^cIf the device is exposed to concentrations higher than the measurement range, it would require a recalibration.

Note: See "[Appendix B](#)" for supplemental information about sensor types and gases.

Table 5.6 Sensor specifications, Sulfur Dioxide
SO₂ for Tango TX2; part number 17160206

Properties	
Category	Toxic
Technology	Electrochemical
Installation location	
	1 or 2
Operating conditions ^a	
Temperature range	-20 to +50 °C (-4 to +122 °F)
RH range	15-95%
Performance	
Sensitivity	
Measurement range ^c	0–150 ppm
Measurement resolution	0.1 ppm
Accuracy ^b	
Calibration gas and concentration	10 ppm SO ₂
Accuracy at time and temperature of calibration	± 10% (0-30 ppm); ± 15% (30.1-150 ppm)
Accuracy over sensor's full temperature range	± 15%
Response Time	
T50	20 s
T90	80 s

^aDuring continuous operation.

^bApply when the instrument is calibrated using the stated calibration gas and concentration; accuracy is equal to the stated percentage or one unit of resolution, whichever is greater.

^cIf the device is exposed to concentrations higher than the measurement range, it would require a recalibration.

Note: See "[Appendix B](#)" for supplemental information about sensor types and gases.

Power

Table 5.7 Battery properties

Battery Pack	Properties
Tadiran TL 5955	Replaceable ^a
3.6 V Primary Lithium-thionyl chloride (Li-SOCl ₂), 1.5AH, 2/3AA	Nonrechargeable Two-year run time depending on operating conditions: the amount of time the unit is in alarm; and the enablement of unit's confidence indicator, bump test due alert, calibration due alert, and gas-alert.

^aSee [Service Task](#) for instructions. Some restrictions may apply (see "General Information, [Error! Reference source not found.](#)").

Dock

The Tango TX2 is compatible with DSX® Docking Stations equipped with a Tango cradle.

DSX docking stations and other accessories, which are supported by iNet, DSSAC, or Accessory Software, can be used to download instrument upgrades and perform maintenance procedures when the instrument is docked.

Maintenance

Docking Station for Maintenance

Manual Processes for Maintenance

Cleaning the Instrument Exterior

Docking Station for Maintenance

Use the DSX® docking station equipped with a Tango® cradle to dock the Tango TX2 and complete instrument maintenance.

- iNet® scheduled maintenance due will be automatically completed upon docking.
- On-demand instrument maintenance can be completed using the dock's UI buttons.

Manual Processes for Maintenance

Use the information provided below to manually perform bump testing, zeroing, and calibration.

- Work in an area known to be nonhazardous.
- Use certified Industrial Scientific calibration gas.
- Choose gas cylinders that are suitable for the installed sensors and their calibration gas settings.

The instrument may be set for the “quick” or “standard” process-type for calibration and bump testing.

The “quick” process permits only one application of gas. This setting is suitable when using a “blended” gas cylinder—one cylinder containing both required calibration gases.

The “standard” process will prompt its user for the application of each required gas, one at a time. Between gases, the standard process allows up to five minutes for a change of cylinders. The standard setting is suitable when more than one gas cylinder is needed to deliver the required calibration gases.

Process At-a-glance

Whether bump testing or calibrating manually, the basic steps are:

- Gather the needed supplies.
- Prepare the gas cylinder for use.
- Access the utility on the instrument.
- Start the utility.
- Connect the calibration cup to the instrument.

- Turn on the gas cylinder.
- View the results.
- Remove the calibration cup.
- *Turn off the gas cylinder.*

Figure 6.1 Instruction for manually performed maintenance

Supplies

- Calibration cup (shipped with the instrument)
- Calibration tubing (shipped with the instrument)
- Calibration gas cylinder suitable for the installed sensors and the instrument's calibration gas settings
- Positive-flow regulator suitable for the calibration gas cylinder

Accessory preparation



Holding the regulator, turn the gas cylinder in a clockwise direction to tighten.



Connect either end of the calibration tubing to the regulator's nipple.



Connect the other end of the tubing to the calibration cup.

Proceed with the instruction set below for the desired task.

Zero and calibration

Zero

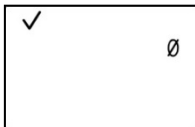

Initiate zero

Note: From operation mode, press until the initiate-zero screen is displayed.

To start the zero process, press .



Zero in-progress

While the sensors are zeroed, the zero-in-progress screens display.

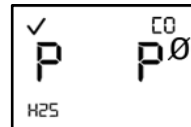

Zero results (pass)

After the sensors are zeroed, results are displayed and an audible alert is emitted.

If *both* sensors pass ("P"), start calibration by pressing ; otherwise, wait approximately 30 seconds for the home screen to display.

If *either* sensor fails ("F"), press to repeat the zero.

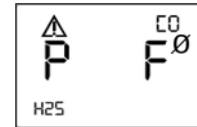

Zero results (H2S pass; CO fail)

Figure 6.1 Instruction for manually performed maintenance

Calibration



Place the calibration cup over the case top; align its top groove with the small ridge at the top of the instrument.

Press down to secure the cup in place; listen for a click.

Visually inspect the calibration cup to ensure its edges align with the edges of the case top.

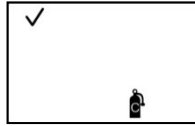
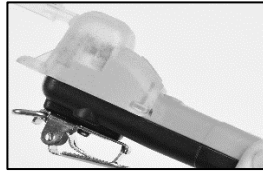

Initiate calibration

To start calibration, press . A blue LED flash with an audible beep indicates the start of calibration.

To cancel calibration, press .

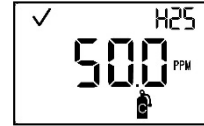

Calibration apply gas

Apply the requested gas.

The instrument will wait up to 5 minutes.

To cancel calibration, press .



To start the flow of gas, turn the regulator knob in a counterclockwise direction.

While the sensors are calibrated, the calibration-in-progress screen displays the span reserve value.

Press to cancel calibration.



Calibration in progress

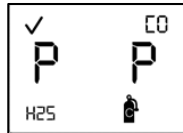

Calibration results (pass)

If *either* sensor fails ("F"), press to repeat the calibration.

If *both* sensors pass ("P"), wait approximately 30 seconds for the home screen to display. A blue LED flash and an audible beep indicate transition from the calibration result screen to home screen.

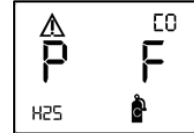

Calibration results (H2S pass; CO fail)

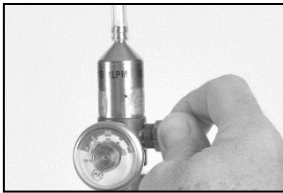

Stop the gas flow! Turn the regulator knob in a clockwise direction and tighten.

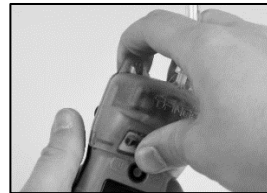

Remove the calibration cup by lifting its tabs; set aside or store for future use.

Figure 6.1 Instruction for manually performed maintenance

Bump testing

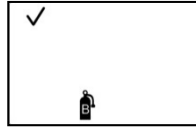
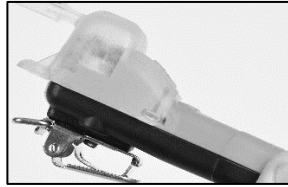

Initiate bump test



Bump test apply gas

Place the calibration cup over the case top; align its top groove with the small ridge at the top of the instrument. Press down to secure the cup in place; listen for a click. Visually inspect the calibration cup to ensure its edges align with the edges of the case top.

To start bump testing, press .
To cancel bump testing, press .

Apply the requested gas. The instrument will wait up to 5 minutes. To cancel bump testing, press .

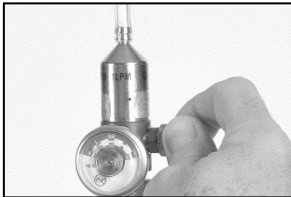

Bump test in progress

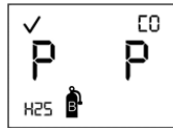

Bump test results (pass)

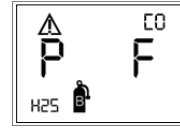

Bump test results (pass and fail)

To start the flow of gas, turn the regulator knob in a counterclockwise direction.

If either sensor fails ("F") bump testing, the instrument will request calibration.

If both sensors pass ("P") bump testing, the home screen will display.

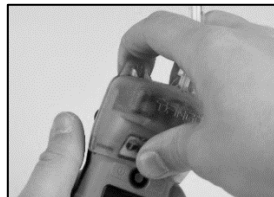
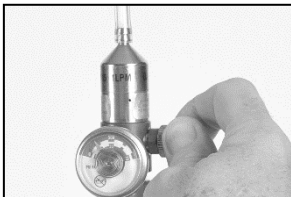

Stop the gas flow! Turn the regulator knob in a clockwise direction and tighten.

Remove the calibration cup by lifting its tabs; set aside or store for future use.

Cleaning the Instrument Exterior

When cleaning the instrument exterior, do not use alcohol, disinfectants, or solvents, or any substance that contains these ingredients as they can damage the gas sensors and otherwise compromise instrument integrity.

For typical dirt and grime, wipe down the instrument with a clean, damp cloth; as needed, use a soap and water solution of 8 to 10 parts water to 1-part dish soap, like Dawn®. To achieve a more serious cleaning, wipe down the instrument with a bleach and water solution of approximately 50 parts water to 1 part bleach as recommended by the US Centers for Disease Control and Prevention (CDC).

7

Service and Warranty

Service

Warranty

Service

Perform all service tasks on a nonconductive surface in a well-lit area that is known to be nonhazardous.

Wear grounding straps to prevent electrostatic discharge (ESD), which can damage the instrument's electronics.

Use care when working with the adhesive-backed filters and gaskets.

- ✓ Be careful not to pierce or tear these items.
- ✓ When using tweezers, apply gentle pressure.
- ✓ Once the adhesive touches a surface, any attempt to remove or reposition the item may cause it damage.

Use care when working with gas sensors and the case top's water barriers.

- ✓ Do not touch the membranes as this can contaminate these items.
- ✓ Use care not to damage the membranes.
- ✓ Use care not to separate the gas sensor from its membrane.

Supplies

T10 Torx screwdriver (for case bottom and clip screws)

Needle-nose tweezers (for barrier and filter service tasks)

Tango TX2 illustrated

The diagrams below show disassembled views of Tango® TX2 and its case top assembly. [Table 7.1](#) identifies parts, part numbers, and whether an item is customer-replaceable or serviced only by Industrial Scientific.

Illustration 7.1 Disassembled Tango TX2 and case-top assembly

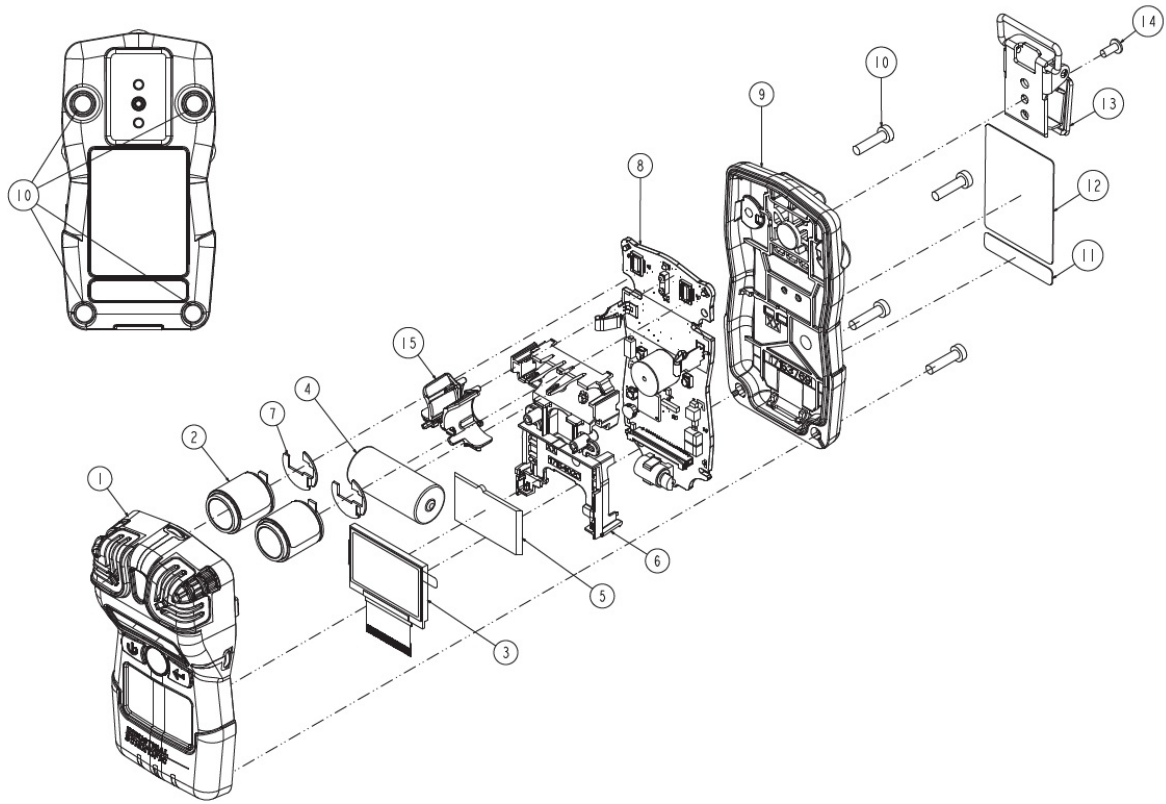

Instrument

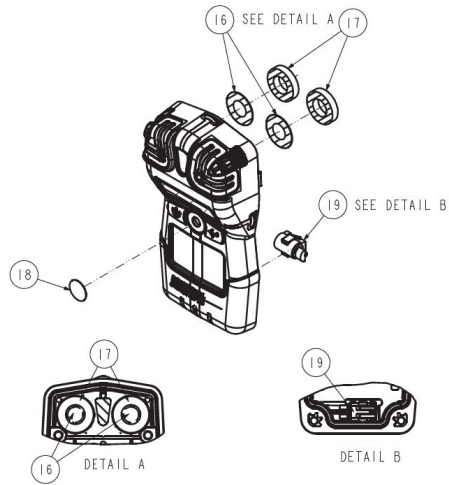

Case top assembly

Table 7.1 Tango TX2 parts list

Diagram number	Part name	Field replaceable	Part number	Notes
—	Case-top assembly	Yes	17160229	Assembly includes the parts labeled with diagram numbers: 1, 15, 16, 17, 18, and 19.
1	Case top	Yes	17153952	
15	Sensor support	Yes	17159184	Included with case top assembly; not sold separately.
16	Sensor water-barrier	Yes	17154219	Parts 17154219 and 17158903 should be replaced at the same time. Kit 18109230 contains 10 barriers and 10 gaskets.
17	Sensor water barrier gasket	Yes	17158903	
18	Speaker dust-barrier kit	Yes	18109613	Includes 10 speaker dust barriers. <i>Notes:</i> The dust barriers are <i>not</i> water impenetrable. More frequent replacement service may be needed in harsh environments.
19	Vibration alarm motor	Yes	17127275	—
2	Sensors			
	Carbon Monoxide (CO)	Yes	17160204	Includes sensor and polycarbonate plate.
	Hydrogen Sulfide (H ₂ S)	Yes	17160207	Includes sensor and polycarbonate plate.
	Nitrogen Dioxide (NO ₂)	Yes	17160205	Includes sensor and polycarbonate plate.
	Sulfur Dioxide (SO ₂)	Yes	17160206	Includes sensor and polycarbonate plate.
	Carbon Monoxide with low Hydrogen cross-sensitivity (CO / H ₂ Low)	Yes	17160208	Includes sensor and polycarbonate plate.
7	Polycarbonate plate	Yes	—	Not sold separately; included with each sensor.
4	Battery	Yes	17154367	—
3 and 5	LCD	No ^a	—	
6 and 8	Board assembly	No ^a	—	
9	Case bottom	No ^a	—	
10	Case bottom screws	Yes	17154328	Torque: 85 newton cm (120 ounce-force inch)
11 and 12	Unit labels	No ^a	—	
13	Garment clip	Yes	17159205	—
not shown	Audio alarm amplifier (optional)	Yes	17154915	—
14	T10 Torx screw (for use with installed garment clip)	Yes	17158205	Torque: 81 newton cm (115 ounce-force inch)

^aFor items that are not field-replaceable, [contact](#) Industrial Scientific or a local distributor of Industrial Scientific products.

Service tasks

 Power off the unit before disassembling or performing any service task.

Figure 7.2 Service tasks

Instrument disassembly

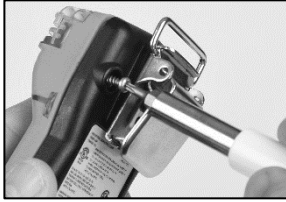

Use a TX10 torx screwdriver to remove all four screws from the case bottom; set aside the screws.

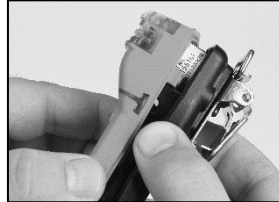

Hold the case bottom near the upper screw holes; carefully begin to lift the case top to separate it from the case bottom.

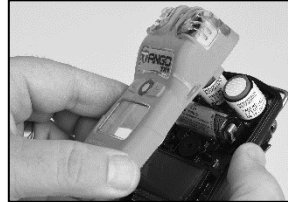

Continue to lift the case top straight up to remove it and to avoid unintentionally loosening the sensors. Complete any needed service, then replace the case top.

Speaker dust barrier replacement



Use your finger or needle-nose tweezers to peel off the dust barrier; discard the used barrier.

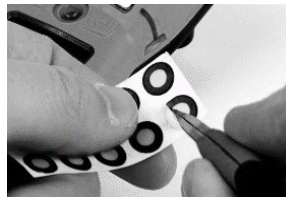

Scrape lightly across the paper to the barrier's edge; gently lift to expose a portion of its adhesive back. Peel the barrier from the sheet.



Guide the new barrier—adhesive side down—onto the case top, positioning it over the speaker. Place your thumb over the dust barrier, press and hold for five seconds to seal the adhesive.

Sensor water-barrier assembly replacement

Note. The sensor water-barrier assembly consists of two parts: the filter and its gasket. Replace both items at the same time.

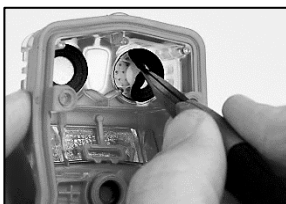

Inside the case top, grip the gasket and underlying sensor filter with the needle-nose tweezers; peel to remove.

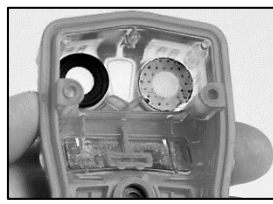

Remove any remnants of the adhesive, filter, or gasket. Clear away any dirt, dust, or debris.

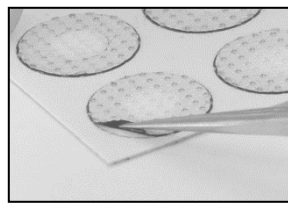

Place the filter sheet on the work surface.

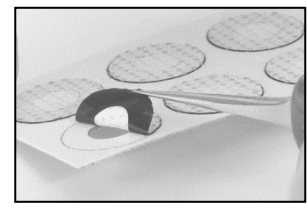

Using tweezers, scrape lightly across the paper to the filter's edge; gently lift to expose a portion of the adhesive back. Grip the filter lightly with the tweezers and peel it from the sheet.

Figure 7.2 Service tasks

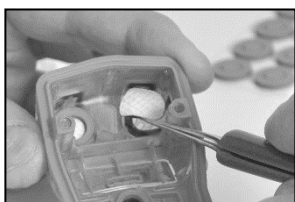

Guide the new filter—adhesive side down—into the filter opening.

For proper placement, take care to ensure the filter edge meets the inner edge of the filter opening.

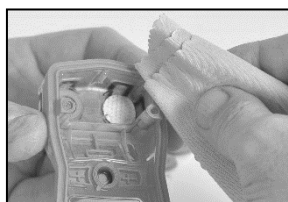

Using a clean, soft cloth, press gently around the filter edge; hold for five seconds to seal the adhesive.

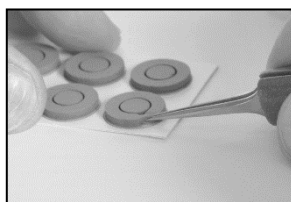

Place the gasket sheet on the work surface.

Using the tweezers, scrape lightly across the paper to the gasket ring's edge; gently lift to expose a portion of the adhesive back.

Grip the gasket ring lightly with the tweezers and peel it from the sheet.

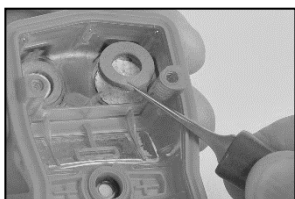
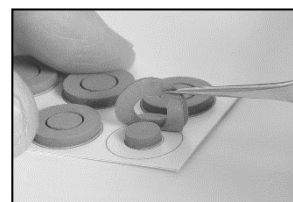

Guide the gasket—adhesive side down—into the filter opening, placing it on top of the filter.

Ensure the gasket ring edge meets the outer edge of the filter opening and fully covers the white filter membrane.

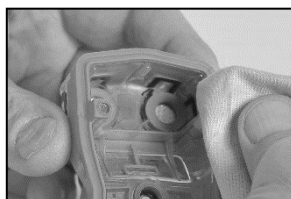

Using a clean, soft cloth, press gently around the gasket edge; hold for five seconds to seal the adhesive.

Vibrating alarm motor replacement

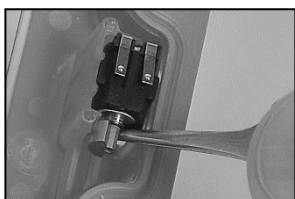

Insert the tweezers between the case top and the motor. Pry up to remove.

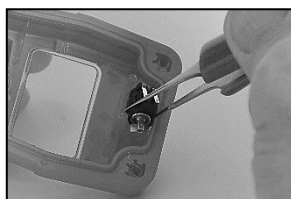
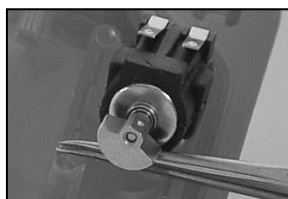

Using the tweezers, gently grip the new motor.

Place the new motor—contact side up—into the case top. Without touching the contacts, use the tweezer handle to press the motor into place.

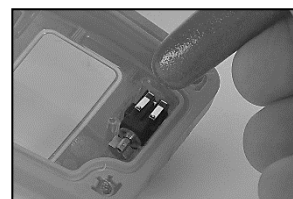

Sensor replacement

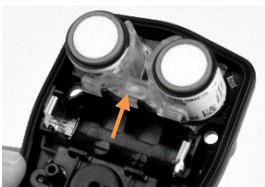

Between the two installed sensors rests a sensor support, which provides added stability for the sensors during operation. Using your thumb and index finger, gently grasp the top and bottom of the sensor support to remove it; set aside.

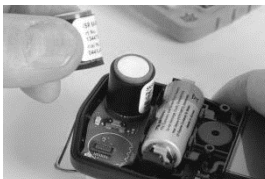

Some sensors may have an adhesive backing holding them in place; use gentle pressure to lift and remove sensors. Set aside for future use or dispose of according to company policy.

Figure 7.2 Service tasks

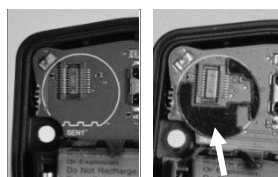

Check the circuit board for a black polycarbonate plate in each sensor position.

The plate is absent in the left image. The right image shows the plate. If both plates are present, skip to sensor placement below.

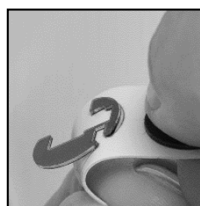

The plates are affixed to a paper backing. Bend the paper backing to separate the plate.

Lightly grip the plate near its top with tweezers; gently lift to completely remove from paper backing.

Guide the plate—adhesive side down—for correct placement on the circuit board as shown above (right).

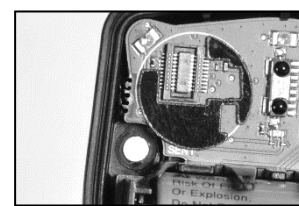
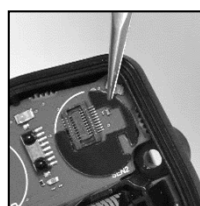

Using a clean, soft cloth, press gently into place.

Sensor and sensor support installation

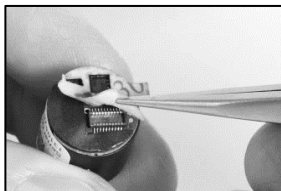

To avoid sensor contamination, handle the sensor by its sides. *Don't touch the sensor top, its membrane.*

Use tweezers to remove the paper liner from the bottom of the sensor and expose the adhesive backing.

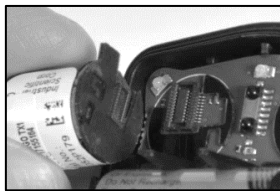

Position the sensor to align with its connector on the circuit board.

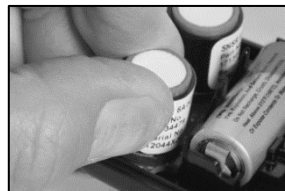

Secure sensor by applying gentle pressure to the sides of the sensor case. *Do not touch the sensor's membrane.*

You will feel a slight connection impact when the sensor is secured in place.

Aligning its wider edge with the battery-cradle edge, reinstall the sensor support between the sensors.

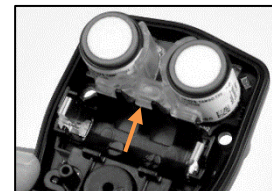

Battery replacement

IMPORTANT: Before removing the battery, power down the Tango device; if this is not done, the instrument data log will be lost.

- The instrument's time and date settings will be lost when the battery is removed from the instrument or the battery is dead. When the instrument is next powered on, it will prompt the user to enter the correct time and date.



Lift the battery up from its cradle.

Dispose of according to company policy.

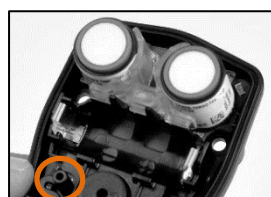

The interior power button is located below the battery cradle to the left of the speaker. Press and hold this button for two seconds, then release it.



Orient the replacement battery so the positive and negative ends align with the "+" and "-" cradle markings, respectively. Place the new battery into the cradle negative end first.

Press down on the battery to secure it in the cradle.

Figure 7.2 Service tasks

Garment clip removal and attachment

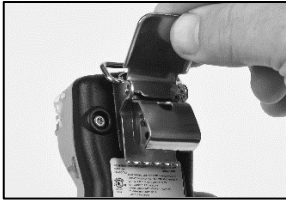

Lift the clip's cover.

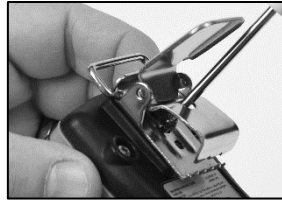

Use a torx screwdriver to remove the clip's screw. Turn counterclockwise to loosen and remove the screw.



Lift the clip to remove it. Close the clip; store it for future use.

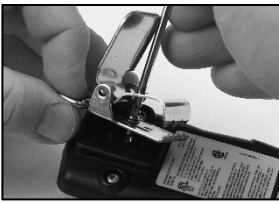

To attach the clip cover, place the screw through the center hole of the clip back.

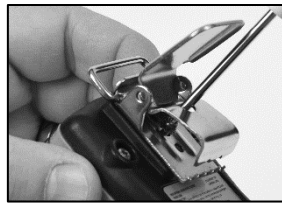

Guide the screwdriver through the clip's hole and into the screw head. Turn clockwise to tighten.

Note: Refer to Table 7.1 for torque values.

Instrument assembly

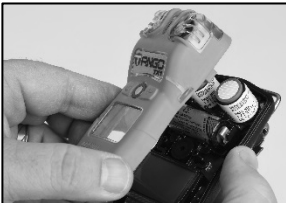

Hold the case bottom near the upper screw holes.

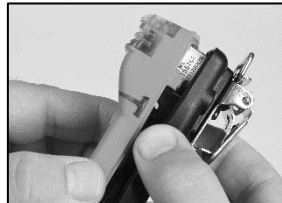

Lower the case top assembly onto the case bottom. Use a straight-down motion to guide the sensors into the sensor barrels.

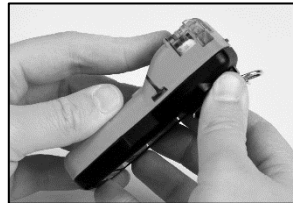

Press to secure the case top and case bottom.

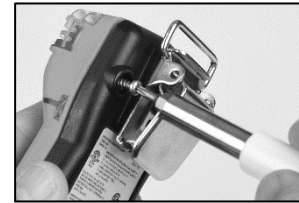

Using a torx screwdriver, insert and tighten each of the four screws into the case bottom.

Note: Refer to Table 7.1 for torque values.

Warranty Policy

Industrial Scientific Corporation's portable Tango® TX2 gas-monitoring instrument is Guaranteed for Life™. Warranted to be free from defects in material and workmanship, under normal and proper use and service for as long as the instrument is supported by Industrial Scientific Corporation.

The above warranty does not include the sensors, battery, or filters, but the sensors carry their own separate warranty. The factory-installed sensors are warranted to be free from defects in material and workmanship under normal and proper use and service as follows, except where otherwise stated in writing in Industrial Scientific literature accompanying the product:

- CO and H₂S sensors are warranted for three years from the initial purchase date.
- All other sensors are warranted for two years from the initial purchase date.

Limitation of Liability

THE WARRANTY SET FORTH ABOVE IS STRICTLY LIMITED TO ITS TERMS AND IS IN LIEU OF ALL OTHER WARRANTIES, GUARANTEES, EXPRESS OR IMPLIED, ARISING BY OPERATION OF LAW, COURSE OF DEALING, USAGE OF TRADE OR OTHERWISE. INDUSTRIAL SCIENTIFIC MAKES NO OTHER WARRANTIES, EITHER EXPRESSED OR IMPLIED, INCLUDING BUT NOT LIMITED TO THE WARRANTIES OF MERCHANTABILITY OR FITNESS FOR PARTICULAR PURPOSE.

Should the product fail to conform to the above warranty, buyer's only remedy and Industrial Scientific's only obligation shall be, at Industrial Scientific's sole option, replacement or repair of such non-conforming goods or refund of the original purchase price of the non-conforming goods.

In no event will Industrial Scientific be liable for any other SPECIAL, INCIDENTAL OR CONSEQUENTIAL OR OTHER SIMILAR DAMAGES, including loss of profit or loss of use, arising out of the sale, manufacture or use of any products sold hereunder whether such claim is pleaded in contract or in tort, including strict liability in tort and whether Industrial Scientific has been advised of the potential for such damages.

Industrial Scientific's total liability hereunder from any cause whatsoever (except liability from personal injury caused by Industrial Scientific's negligence), whether arising under contract, warranty, tort (including negligence), strict liability, products liability or any other theory of liability, will be limited to the lesser of Buyer's actual damages or the price paid to Industrial Scientific for the Products that are the subject of Buyer's claim. All claims against Industrial Scientific must be brought within one year after the cause of action arises, and Buyer expressly waives any longer statute of limitations.

It shall be an express condition to Industrial Scientific's warranty that all products be carefully inspected for damage by Buyer upon receipt, be properly calibrated for Buyer's particular use, and be used, repaired, and maintained in strict accordance with the instructions set forth in Industrial Scientific's product literature. Repair or maintenance by non-qualified personnel will invalidate the warranty, as will the use of non-approved consumables or spare parts.

As with any other sophisticated product, it is essential and a condition of Industrial Scientific's warranty that all personnel using the products be fully acquainted with their use, capabilities and limitations as set forth in the applicable product literature. Buyer acknowledges that it alone has determined the intended purpose and suitability of the goods purchased.

It is expressly agreed by the parties that any technical or other advice given by Industrial Scientific with respect to the use of the goods or services is given without charge and at Buyer's risk; therefore, Industrial Scientific assumes no obligations or liability for the advice given or results obtained.

Appendix A

Maintenance Definitions

Bump Test (or "functional test")

Bump testing is a functional test in which an instrument's installed sensors are to be briefly exposed to (or "bumped" by) calibration gases in concentrations that are greater than the sensors' low-alarm setpoints. This will cause the instrument to go into low alarm and will indicate which sensors pass or fail this basic test for response to gas.

Zero

Zeroing adjusts the sensors' "baseline" readings, which become the points of comparison for subsequent gas readings. It is a prerequisite for calibration. During zeroing, the installed sensors are to be exposed to an air sample from a zero-grade-air cylinder or ambient air that is known to be clean air. If there are gases in the air sample that are below the lowest alarm level, the instrument will read them as zero; its only task is to *read* the air sample as clean air. The user's task is to ensure the air is clean.

Calibration

Regular calibrations promote the accurate measurement of gas-concentration values. During calibration, an instrument's installed sensors are to be exposed to their set concentrations of calibration gases. Based on the sensors' responses, the instrument will self-adjust to compensate for declining sensor sensitivity, which naturally occurs as the installed sensors are used or "consumed".

Note: During calibration, the span reserve percentage value for each sensor is displayed. An indicator of a sensor's remaining life, when the value is less than 50%, the sensor will no longer pass calibration

Appendix B

Supplemental Information about Sensors and Gases

Table B.1 Sensor cross-sensitivity guidelines (percent response)

Target gas	Sensor type				
	Carbon Monoxide %	CO/H ₂ Low %	Hydrogen Sulfide %	Nitrogen Dioxide %	Sulfur Dioxide %
Carbon Monoxide	100.0	100	1.0	1.0	1.0
Hydrogen Sulfide	3.0	5.0	100.0	-90.0	1.0
Sulfur Dioxide	5.0	5.0	5.0	0.0	100.0
Nitrogen Dioxide	4.0	5.0	-24.0	100.0	-123.0
Chlorine	3.0	0	-17.0	26.0	-5.0
Chlorine Dioxide	—	—	—	—	—
Hydrogen Cyanide	15.0	—	-1.0	1.0	2.0
Hydrogen Chloride	3.0	—	0.0	0.0	-1.0
Phosphine	80.0	—	60.0	-138.0	2.0
Nitric Oxide	22.0	40.0	-1.0	1.0	-2.0
Hydrogen	24.0	3.0	0.1	0.0	1.0
Ammonia	1.0	0	0.0	0.0	0.0

Note: This table is provided as a guide only and is subject to change. The data reflect the percentage response of the sensor type when exposed to a known concentration of a target gas. For example, when the carbon monoxide sensor is exposed to carbon monoxide in the air sample, the gas concentration reading accurately reflects the actual concentration of carbon monoxide, so the sensor's response is said to be 100%. When an air sample contains hydrogen, it triggers a carbon monoxide reading. The carbon monoxide sensor's response to hydrogen is approximately 24% meaning that exposure to 100 ppm hydrogen will produce a reading of approximately 24 ppm carbon monoxide.

Appendix C

Marking Requirements

Table C.1 ATEX and IECEx marking requirements

ATEX markings	IECEx markings
Industrial Scientific Corp.	Industrial Scientific Corp.
15205 USA	15205 USA
TANGO TX2	TANGO TX2
DEMKO 12 ATEX 1209126	IECEx UL12.0041
Ex ia I Ma	Ex ia I Ma
Ex ia IIC T4 Ga	Ex ia IIC T4 Ga
-40°C ≤ Ta ≤ +50°C	-40°C ≤ Ta ≤ +50°C
[Serial Number] [Month/Year of Production]	[Serial Number] [Month/Year of Production]

Contact Information

Industrial Scientific Corporation

1 Life Way
Pittsburgh, PA 15205-7500 USA
Web: www.indsci.com
Phone: +1 412-788-4353 or 1-800-DETECTS (338-3287)
E-mail: info@indsci.com
Fax: +1 412-788-8353

Industrial Scientific France S.A.S.

11D Rue Willy Brandt
62002 Arras Cedex, France
Web: www.indsci.com
Téléphone : +33 (0)1 57 32 92 61
E-mail: info@eu.indsci.com
Fax: +33 (0)1 57 32 92 67

英思科传感仪器（上海）有限公司

地址：中国上海市浦东金桥出口加工区桂桥路290号
邮编：201206
电话：+86 21 5899 3279
传真：+86 21 5899 3280
E-mail： iscapinfogroup@indsci.com
网址： www.indsci.com
服务热线：+86 400 820 2515

To locate a nearby distributor of our products or an Industrial Scientific service center or business office, visit us at www.indsci.com.

Rendez-vous sur notre site Web www.indsci.com, si vous voulez trouver un distributeur de nos produits près de chez vous, ou, si vous recherchez un centre de service ou un bureau Industrial Scientific.

Besuchen Sie uns unter www.indsci.com, um einen Vertriebshändler unserer Produkte oder ein Servicecenter bzw. eine Niederlassung von Industrial Scientific zu finden.

Para buscar un distribuidor local de nuestros productos o un centro de servicio u oficina comercial de Industrial Scientific, visite www.indsci.com.

如需查找就近的产品经销商或 Industrial Scientific 服务中心或业务办事处，请访问我们的网站 www.indsci.com。

INDUSTRIAL

SCIENTIFIC