

NEED HELP?

SCAN OR CLICK HERE
TO CONTACT US



Air-Met Scientific
www.airmet.com.au

RADIUS[®] BZ1



Product Manual

*The Essential Guide for
Safety Teams and
Instrument Operators*

Edition: 15
May 13, 2022
Part Number: 17155915-1

INDUSTRIAL
SCIENTIFIC

Industrial Scientific Corporation, Pittsburgh, PA USA

Industrial Scientific Co., Ltd. Shanghai, China

© 2016, 2017, 2018, 2019, 2020, 2021, 2022 Industrial Scientific Corporation

All rights reserved. Published 2022.

Version 17



www.indsci.com/radius

Contents

General Information	1
Certifications	1
Warnings and Cautionary Statements	2
Recommended Practices	4
First-use Checklist	4
Placement Guidelines	4
Gas and site factors	4
Wireless and GPS factors	4
Maintenance	5
Settings	6
Utilities	6
Biased Sensors	7
Remote Sampling	8
Care and Storage	9
Product Information	11
Instrument Overview	11
Area Monitoring and Connected Safety	11
Area monitoring	11
Connected safety	11
Team safety	11
Live monitoring	11
Key Features	12
Alarms	12
Gas alarms	12
Latch alarm	12
Unique alarm action messages	12
Connected safety	12
LENS Wireless	13
iNet Now	13
Power options	13
Always-on	13
Charging	13
Additional features	13
DualSense Technology	13
Modularity	13

Quick-status.....	13
Compatibilities	14
Batteries	14
Power supplies	14
Sensors	15
Docking station and software.....	15
Sample tubing kits	16
Specifications.....	16
Instrument.....	16
Batteries	17
Sensors	17
Getting Started	41
Unpacking.....	41
Hardware Overview	42
Setup	44
Display Overview	45
Settings.....	49
Guidelines.....	49
Accessing Settings	49
Settings Overview.....	50
Display Overview (settings)	50
Working in Settings.....	52
Reviewing and Editing Settings	53
Maintenance Options and Settings.....	53
Start-up Settings.....	54
Operation Settings.....	54
Alarm Settings	55
Sensor Settings	57
Admin Settings	58
Wireless Settings.....	60
Power	65
Charging the Battery.....	65
Power on	66
Shutdown.....	69
Quick-status Information	69
Maintaining Battery Charge	69
Operation.....	71
Placing the Instrument.....	71
In-field Precautions	71
LENS Wireless.....	72

Live Monitoring	72
RGX Gateway and TGX Gateway	72
Smart-device gateway	73
Gas Readings.....	73
Operating the Instrument.....	74
Information.....	74
Utilities.....	74
Alarms, Warnings, and Indicators.....	76
Alarms	76
Warnings	79
Indicators.....	79
Resolving Failures and Errors.....	80
Maintenance	83
Overview.....	83
Guidelines.....	83
Process At-a-glance	83
Supplies and Preparation	84
Instructions	84
Service and Warranty	87
Service.....	87
Guidelines	87
Supplies.....	87
Instruction.....	88
Warranty.....	95
Limitation of Liability	95
Appendix A	97
Supplemental Information about Gases and Sensors.....	97
Cross Sensitivity and Toxic Gases	97
LEL and Combustible Gases	98
Appendix B	99
Extended Run Time Power Supply (ERTPS)—supplemental information	99
Appendix C.....	100
Intrinsically Safe Extended Run Time Power Supply (ISERTPS)—supplemental information	100
Appendix D.....	101
Solar Power Supply (SPS)—supplemental information	101
Contact Information	102

Tables and Figures

Table 1.1 Hazardous area certifications	1
Table 1.2 Wireless certifications and directives	2
Table 1.3 Warnings and cautionary statements.....	2
Figure 1.1 Sample placement plan for instruments in a LENS group	5
Table 1.4 Range guidelines for LENS Wireless connections by LENS power mode setting.....	5
Table 1.5 Recommended frequencies for instrument maintenance.....	7
Table 1.6 Minimum sample time for common sample-line lengths	9
Table 1.7 Storage temperature and duration for a fully charged unit.....	9
Figure 2.1 Industrial Scientific connected safety system	12
Table 2.1 Compatible batteries.....	14
Table 2.2 Compatible power supplies.....	14
Figure 2.2 Compatible sensors and installation locations	15
Table 2.3 Instrument specifications	16
Table 2.4 Battery specifications.....	17
Table 2.5 Sensor specifications, Ammonia.....	18
Table 2.6 Sensor specifications, Carbon Dioxide	19
Table 2.7 Sensor specifications, Carbon Monoxide.....	20
Table 2.8 Sensor specifications, Carbon Monoxide (high range).....	21
Table 2.9 Sensor specifications, Carbon Monoxide with low Hydrogen cross-sensitivity	22
Table 2.10 Sensor specifications, Carbon Monoxide and Hydrogen Sulfide	23
Table 2.11 Sensor specifications, Chlorine.....	24
Table 2.12 Sensor specifications, Chlorine Dioxide.....	25
Table 2.13 Sensor specifications, Hydrogen	26
Table 2.14 Sensor specifications, Hydrogen Chloride	27
Table 2.15 Sensor specifications, Hydrogen Cyanide	28
Table 2.16 Sensor specifications, Hydrogen Sulfide.....	29
Table 2.17 Sensor specifications, Hydrocarbon, IR (Propane)	30
Table 2.18 Sensor specifications, LEL Methane.....	31
Table 2.19 Sensor specifications, LEL Pentane	32
Table 2.20 Sensor specifications, Methane, IR	33
Table 2.21 Sensor specifications, Nitric Oxide	34
Table 2.22 Sensor specifications, Nitrogen Dioxide.....	35
Table 2.23 Sensor specifications, Oxygen.....	36
Table 2.24 Sensor specifications, Phosphine	37
Table 2.25 Sensor specifications, Sulfur Dioxide.....	38

Table 2.26 Sensor specifications, Volatile Organic Compounds.....	39
Table 3.1 Package contents	41
Figure 3.1.A Hardware overview Radius BZ1 (front view; diffusion)	42
Figure 3.1.B Hardware overview Radius BZ1 (back view; aspirated)	43
Figure 3.2 Setup	44
Figure 3.3 Display overview (operational instrument).....	47
Table 4.1 Settings overview.....	50
Figure 4.1 Display screen overview in settings.....	51
Figure 4.2 Example for editing a single-step setting	52
Figure 4.3 Example for editing a multistep setting	52
Table 4.2 Maintenance options and settings	53
Table 4.3 Start-up settings.....	54
Table 4.4 Operation settings.....	55
Table 4.5 Alarm settings	56
Table 4.6 Sensor settings	57
Table 4.7 Admin settings	58
Table 4.8 Wireless settings.....	60
Figure 5.1 Battery charging instructions	66
Figure 5.2 Power-on process.....	68
Figure 5.3 Shut-down process.....	69
Table 5.1 Power supply run-time effects.....	69
Figure 6.1 Home screen variations	73
Figure 6.2 Operation instruction	75
Figure 6.3 Alarm-signal intensity	76
Figure 6.4 Example alarm and peer-alarm display-screens.....	77
Figure 6.5 Alarms, possible causes, and relative signal intensity	78
Figure 6.6 Example warning display-screens	79
Table 6.1 Warnings and indicators; causes and signal frequency	80
Table 6.2 Failures and errors.....	81
Figure 7.1 Maintenance supplies and preparation.....	84
Figure 7.2.A Zeroing instructions	84
Figure 7.2.B Calibration instructions	85
Figure 7.2.C Bump test instructions.....	86
Figure 8.1 Parts diagram for SafeCore Module and Radius Base	88
Table 8.1 Parts table for SafeCore Module and Radius Base	88
Figure 8.2 Service tasks, Radius Base	91

Figure 8.3 Service tasks, SafeCore Module	94
Table A.1 Cross-sensitivity guidelines (%).....	97
Table A.2 LEL correlation factors.....	98
Figure B.1 Control drawing 1810D9387-200 revision 3	99
Figure C.1 Control drawing 1810D9387-200 revision 3	100
Figure D.1 Control drawing 18109634-200 revision 3.....	101

General Information

Certifications

Warnings and Cautionary Statements

Recommended Practices

Certifications

Radius® BZ1 Area Monitors can be manufactured to meet a variety of certifications including those listed below in Tables 1.1 and 1.2. To determine the hazardous area classifications for which an instrument is certified, refer to its label or the instrument order.

Table 1.1 Hazardous area certifications

Certifying Body	Area Classifications	Approved Temperature Range
ATEX	Ex da ia IIC T4 Ga, Equipment Group and Category II 1G Ex db ia IIC T4 Gb with IR sensor installed, Equipment Group and Category II 2G	-20 °C to +55 °C (-4 °F to + 131 °F)
China EX	Ex d ia IIC T1 Ga; Ex d ia IIC T4 Gb IR sensor; CPC	-20 °C to +55 °C (-4 °F to + 131 °F)
CSA ^a	Class I, Division 1, Groups A, B, C, and D; T4 Ex da ia IIC T4 Ga C22.2 No. 152 applies only to %LEL thermo-catalytic reading	-20 °C to +55 °C (-4 °F to +131 °F)
IECEX	Ex da ia IIC T4 Ga Ex db ia IIC T4 Gb with IR sensor installed	-20 °C to +55 °C (-4 °F to + 131 °F)
INMETRO	Ex da ia IIC T4 Ga Ex db ia IIC T4 Gb with IR sensor installed	-20 °C to +55 °C (-4 °F to + 131 °F)
KC	Ex d ia IIC T4	-20 °C to +55 °C (-4 °F to + 131 °F)
MASC IA	Ex da ia IIC T4 Ga Ex db ia IIC T4 Gb with IR sensor installed	-20 °C to +55 °C (-4 °F to + 131 °F)
UL	Class I, Division 1, Groups A, B, C, and D; T4 Class 1 Zone 0 AEx da ia IIC T4 Ga Class 1 Zone 0 AEx db ia IIC T4 Gb with IR sensor installed	-20 °C to +55 °C (-4 °F to + 131 °F)

^aThe following apply to instruments that are to be used in compliance with the CSA certification:

Radius BZ1 Area Monitor is CSA-certified according to the Canadian Electrical Code for use in Class I, Division 1 and Zone Classified Hazardous Locations within an ambient temperature range of T_{amb} : -20 °C to +55 °C.

CSA has assessed only the %LEL thermo-catalytic combustible gas detection portion of this instrument for performance according to CSA Standard C22.2 No. 152 within an ambient temperature range of T_{amb} : -20 °C to +55 °C. This is applicable when the monitor is used in the diffusion or aspirated mode and has been calibrated to 50% LEL CH₄.

In addition to the certifications listed below, refer to the Industrial Scientific websites for the most up-to-date information about wireless product [certifications](#).

Table 1.2 Wireless certifications and directives

Agency or authority	Identification number or registration number	Country or region
CE Radio Equipment Directive (RED) ^a	N/A	Multiple
FCC ^b	Contains FCC ID: U90-SM220	USA
IC ^b	7084-SM220	Canada
ISED-Canada	Contains IC: 7084A-SM220	Canada

^aUse the LENS power-mode setting to control whether the instrument's radio-power transmission level is or is not in compliance with the CE RED.

^bMarking requirements INDUSTRIAL SCIENTIFIC CORP.; SAFECORE MODULE; Contains SM220; FCC ID: U90-SM220; Contains IC: 7084A-SM220

Warnings and Cautionary Statements

Read and understand this manual before operating or servicing the instrument. Failure to perform certain procedures or note certain conditions—provided in Table 1.3 and throughout the manual—may impair the performance of the product, cause unsafe conditions, or both.

Table 1.3 Warnings and cautionary statements











	If it appears that the instrument is not working correctly, immediately contact Industrial Scientific.
	For safety reasons, this equipment must be operated and serviced by qualified personnel only. Pour des raisons de sécurité, cet équipement doit être utilement entretenu et réparé uniquement par un personnel qualifié.
	WARNING: SUBSTITUTION OF COMPONENTS MAY IMPAIR INTRINSIC SAFETY. AVERTISSEMENT: LA SUBSTITUTION DE COMPOSANTS PEUT COMPROMETTRE LA SÉCURITÉ INTRINSÈQUE.
	Do not use in oxygen-enriched atmospheres. If the atmosphere becomes oxygen enriched, it may cause inaccurate readings.
	Oxygen-deficient atmospheres may cause inaccurate readings.
	Sudden changes in atmospheric pressure may cause temporary fluctuations in gas readings.
	A rapid increase in a gas reading that is followed by a declining or erratic reading may indicate an over-range condition, which may be hazardous.
	Silicone and other known contaminants may damage the instrument's combustible gas sensors, which can cause inaccurate gas readings.
	Do not use solvents or cleaning solutions on the instrument or its components.
	To support accurate readings, keep clean and unobstructed all filters, ports, and water barriers.

Table 1.3 Warnings and cautionary statements













	Perform all instrument service tasks in nonhazardous locations only. A service task is defined as the removal, replacement, or adjustment of any part on or inside the SafeCore® Module or Radius Base. Always power off the instrument before performing any service task.														
	Perform the maintenance procedures of zeroing, calibration, and bump testing in nonhazardous locations only.														
	The Radius Base battery pack must be fully charged before its first use.														
	The Radius Base battery pack is to be replaced only by Industrial Scientific Corporation or authorized repair facility.														
	<p>WARNING - DO NOT CHARGE THE BATTERY IN HAZARDOUS LOCATION. AVERTISSEMENT - NE PAS CHARGER L'ACCUMULATEUR DANS UN EMPLACEMENT DANGEREUX.</p> <p>The compatible charging power supply (17155923) and cord is to be connected and used only in a nonhazardous location. When the Radius BZ1 or Radius Base is in a hazardous location, the charging power supply cap must be installed</p>														
	<p>WARNING - ONLY CONNECT AND USE COMPATIBLE POWER SUPPLY ACCESSORIES FROM INDUSTRIAL SCIENTIFIC IN HAZARDOUS LOCATIONS ACCORDING TO INDUSTRIAL SCIENTIFIC CONTROL DRAWING 1810D9387-200 or 18109634-200. AVERTISSEMENT - SE CONNECTER ET UTILISER UNIQUEMENT DES ACCESSOIRES D'ALIMENTATION COMPATIBLES DE L'INDUSTRIAL SCIENTIFIC DANS DES ENDROITS DANGEREUX SELON LE SCHÉMA DE CONTRÔLE SCIENTIFIQUE INDUSTRIEL 1810D9387-200 ou 18109634-200.</p> <p>Access to the control drawing is provided in the accessory's product manual as listed below, and in the Appendices of this publication. Use each accessory in accordance with its <i>Product Manual</i>.</p> <p>When a power supply accessory is <i>not</i> in use and the instrument or its base is in a hazardous-classified area, the IS power port cap must be installed.</p> <table border="1" data-bbox="324 987 1299 1144"> <thead> <tr> <th>Power supply accessory</th> <th colspan="2">Product manual part number</th> </tr> </thead> <tbody> <tr> <td>Extended Run Time Power Supply</td> <td colspan="2">17158385</td> </tr> <tr> <td>Intrinsically Safe Extended Run Time Power Supply</td> <td colspan="2">17158248</td> </tr> <tr> <td>Solar Power Supply</td> <td colspan="2">17159773</td> </tr> </tbody> </table>			Power supply accessory	Product manual part number		Extended Run Time Power Supply	17158385		Intrinsically Safe Extended Run Time Power Supply	17158248		Solar Power Supply	17159773	
Power supply accessory	Product manual part number														
Extended Run Time Power Supply	17158385														
Intrinsically Safe Extended Run Time Power Supply	17158248														
Solar Power Supply	17159773														
	<p>The Radius BZ1 LENS radio generates radio-frequency energy. The frequency and output powers are based on the LENS power-mode setting.</p> <table border="1" data-bbox="324 1228 1347 1354"> <thead> <tr> <th>LENS Power Mode setting</th> <th>Frequency</th> <th>Maximum radiated transmit power</th> </tr> </thead> <tbody> <tr> <td>World</td> <td>2405–2480 MHz</td> <td>20 dBm (100 mW)</td> </tr> <tr> <td>CE RED</td> <td>2405–2480 MHz</td> <td>9.4 dBm (8.7 mW)</td> </tr> </tbody> </table>			LENS Power Mode setting	Frequency	Maximum radiated transmit power	World	2405–2480 MHz	20 dBm (100 mW)	CE RED	2405–2480 MHz	9.4 dBm (8.7 mW)			
LENS Power Mode setting	Frequency	Maximum radiated transmit power													
World	2405–2480 MHz	20 dBm (100 mW)													
CE RED	2405–2480 MHz	9.4 dBm (8.7 mW)													
	<p>Contains wireless device model SM220, FCC ID: U9O-SM220. This device complies with Part 15 of the FCC Rules. Operation is subject to the following two conditions: (1) This device may not cause harmful interferences, and (2) this device must accept any interference received, including interference that may cause undesired operation.</p>														
	<p>This equipment has been tested and found to comply with the limits for a Class A digital device, pursuant to part 15 B and C of the FCC Rules. These limits are designed to provide reasonable protection against harmful interference when the equipment is operated in a commercial environment. This equipment generates, uses, and can radiate radio frequency energy and, if not installed and used in accordance with the instruction manual, may cause harmful interference to radio communications. Operation of this equipment in a residential area is likely to cause harmful interference in which case the user will be required to correct the interference at his own expense.</p> <p>The instrument complies with part 15 of the FCC Rules. Operation is subject to the following two conditions:</p> <ul style="list-style-type: none"> • This device may not cause harmful interference. • This device must accept any interference received, including interference that may cause undesired operation. <p>Changes or modification made that are not expressly approved by the manufacturer could void the user's authority to operate the equipment.</p>														

Table 1.3 Warnings and cautionary statements

	This equipment may not cause interference with duly authorized systems and is not entitled to protection from harmful interference.
	RF Exposure: This equipment complies with radiation exposure limits set forth for an uncontrolled environment by the Federal Communications Commission (FCC) of the United States; Innovation, Science and Economic Development Canada (ISED); and the European Council recommendation on the limitation of exposure of the general public to electromagnetic fields (1999/519/EC). This equipment should be installed and operated with minimum distance of 20 cm (8 ") between the radiator and your body. This transmitter must not be co-located or operated in conjunction with any other antenna or transmitter.
	Industrial Scientific recommends persons with a pacemaker or implantable cardio defibrillator (ICD) should maintain a minimum separation distance of 20 cm (8 ") between the pacemaker or ICD and a wireless enabled instrument. Please consult your physician or pacemaker or ICD manufacturer for additional guidance and recommendations.
	This device complies with Industry Canada license-exempt RSS standard(s). Operation is subject to the following two conditions: (1) this device may not cause interference, and (2) this device must accept any interference, including interference that may cause undesired operation of the device. Le présent appareil est conforme aux CNR d'Industrie Canada applicables aux appareils radio exempts de licence. L'exploitation est autorisée aux deux conditions suivantes: (1) l'appareil ne doit pas produire de brouillage, et (2) l'utilisateur de l'appareil doit accepter tout brouillage radioélectrique subi, même si le brouillage est susceptible d'en compromettre le fonctionnement.

Recommended Practices

First-use Checklist

To prepare the Radius BZ1 instrument for first use, qualified personnel should complete the following:

- Set up the instrument; charge the battery.
- Review instrument settings and adjust as needed.
- Calibrate the instrument; complete a bump test.
- Train instrument users.

Placement Guidelines

To develop a placement plan for each unique, in-field application of Radius BZ1 instruments, keep in mind all relevant gas, site, and LENS™ Wireless (Linked Equipment Network for Safety) factors, which include but are not limited to the following.

Gas and site factors

- Know the densities of the target gases.
- Know or try to anticipate the locations of potential leaks and other prospective gas events.
- Consider the site's air temperature and its air-flow factors such as velocity and direction.
- Consider the site's terrain.

Wireless and GPS factors

Radius BZ1 gas-detection instruments are equipped with a radio that wirelessly connects equipment items. This permits the sharing of data (e.g., alarms) among instruments within a LENS Wireless group. LENS also supports the exchange of instrument data with iNet®, via a compatible gateway such as the RGX™ Gateway. This facilitates the live monitoring* of instruments within the group.

*Note: Available when the iNet Now service and all to-be-monitored instruments have been activated for live monitoring

- For instruments that operate in a LENS Wireless peer group, be aware that LENS peers communicate in a nonlinear manner. These peers can include other instruments and gateways. With the placement of units A through F as shown below in Figure 1.1, messages can travel among LENS group peers that may be separated by a structure (gray bar).
- When using LENS Wireless, ensure each instrument has joined or been assigned to the desired LENS group and is positioned within range of at least one peer in its group.
- To maintain each LENS connection type, use the range guidelines supplied below (see Table 1.4). As shown, the communication range may vary based on the unit’s LENS power-mode setting—whether it is set for compliance with the CE Radio Equipment Directive (RED). To view or change the current setting, see chapter 4, “Settings.”

To achieve best performance for a unit that will use GPS, ensure the site provides ample open-sky access. Units used in an indoor environment *cannot* receive the signal required for GPS functionality.

As needed, supervise the in-field placement of instruments (see chapter 6, "Operation").

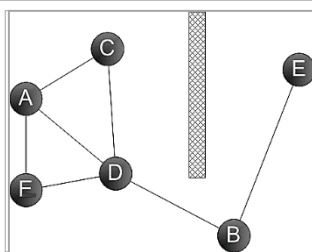

Figure 1.1 Sample placement plan for instruments in a LENS group

Table 1.4 Range guidelines for LENS Wireless connections by LENS power mode setting

	Line-of-sight distance, maximum	
	World setting	CE RED setting ^a
Radius BZ1 to Radius BZ1	300 m (328 yd)	185 m (202 yd)
Radius BZ1 to Ventis Pro	100 m (109 yd) ^a	100 m (109 yd)
Radius BZ1 to RGX Gateway	300 m (328 yd)	185 m (202 yd)
Radius BZ1 to TGX Gateway	100 m (109 yd)	100 m (109 yd)

^aApplies when the equipment items face each other.

Maintenance

The procedures defined in this section help to maintain instrument functionality, support worker safety, and test and calibrate for sensor response to gas including the effects of sensor drift. Sensor drift is defined as a gradual shift in sensor output, which causes an error in the displayed gas reading. The shift can be either positive or negative and is typically caused by the conditions listed below.

- There are changes in environmental conditions such as temperature, pressure, humidity, or thermal conductivity of the air.
- The sensor has cross sensitivity* to nontarget gases and has been directly exposed to one or more of those gases, or is experiencing lingering, temporary effects from this type of exposure.

- The sensor has been zeroed or calibrated in an atmosphere that contains some concentration of the sensor's target gas or some concentration of nontarget* gas to which the sensor responds.
- There are changes in the power state of a biased sensor. Biased sensors require continuous power and may take time to stabilize after being in a state of low or no power. Biased sensors installed in the SafeCore® Module are powered only by the module's "backup battery" when the module is out of the Radius Base or docking station. When the module is returned to the docking station or Radius Base, there will be a warm-up period.

*Note: For more information about the cross sensitivities of nontarget gases see Appendix A, "[Supplemental Information about Gases and Sensors](#)."

Industrial Scientific minimum-frequency recommendations for instrument maintenance are summarized below in Table 1.5. These recommendations are based on field data, safe work procedures, industry best practices, and regulatory standards. Industrial Scientific is not responsible for determining a company's safety practices or establishing its safety policies, which may be affected by the directives and recommendations of regulatory groups, environmental and operating conditions, instrument use patterns and exposure to gas, and other factors.

Settings

Settings control how an instrument will perform. They are used to support compliance with company safety policy and applicable regulations, laws, and guidelines as issued by regulatory agencies and government or industry groups.

Utilities

Maintenance procedures are known as "utilities." Utilities are used to test the instrument or its components for functionality or performance, or to complete other maintenance tasks. Each utility is defined below.

Self-test

The self-test checks the functionality of the instrument's memory operations, battery, display screen, and each alarm-signal type (audible and visual).

Bump Test^a

Bump testing is a functional test in which an instrument's installed sensors are briefly exposed to (or "bumped" by) calibration gases in concentrations that are greater than the sensors' low-alarm setpoints. This will cause the instrument to go into low alarm and will indicate which sensors pass or fail this basic test for response to gas.

Zeroing^a

Zeroing adjusts the sensors' "baseline" readings, which become the points of comparison for subsequent gas readings. During zeroing, which is a prerequisite for calibration, the installed sensors are exposed to an air sample from a zero-grade-air cylinder or ambient air that is known to be clean air. If there are gases in the air sample that are below the lowest alarm level, the instrument will read them as zero; its task is to read the air sample as clean air. The user's task is to ensure that the air is clean.

Calibration^a

Regular calibration promotes the accurate measurement of gas concentration values. During calibration, an instrument's installed sensors are exposed to set concentrations of calibration gases. Based on the sensors' responses, the instrument will self-adjust to compensate for declining sensor sensitivity, which occurs as the installed sensors are used or "consumed."

Note: After calibration, the span reserve percentage value for each sensor is displayed. An indicator of a sensor's remaining life, when the value is less than 50%, the sensor will no longer pass calibration.

Docking

When docked, instruments that are supported by iNet Control or DSSAC (Docking Station Software Admin Console) will be updated for all scheduled bump tests and calibration procedures, synchronized for any changes to settings, and upgraded for advances from Industrial Scientific.

Other Maintenance

The time-weighted average (TWA), short-term exposure limit (STEL), and peak readings can each be "cleared." When any summary reading is cleared, its value is reset to zero and its time-related setting is also reset to zero.

^aComplete only in areas known to be nonhazardous.

Table 1.5 Recommended frequencies for instrument maintenance

Procedure	Recommended minimum frequency
Settings	Before first use, when an installed sensor is replaced, and as needed.
Zeroing	Before first use; thereafter, zero the instrument every two weeks or when sensor drift is observed.
Calibration ^a	Before first use and monthly thereafter.
Bump test ^b	Before first use; thereafter, for sensors <i>not</i> operating in DualSense™ mode, prior to each day's use and, for sensors operating in DualSense ^c mode, as needed between monthly calibrations.
Self-test ^d	As needed.

^aBetween regular calibration procedures, Industrial Scientific also recommends that calibration be performed immediately following each of these incidences: the unit falls, is dropped, or experiences another significant impact; fails a bump test; has been repeatedly exposed to an over-range (positive or negative) gas concentration; or its sensors are exposed to water or contaminants. Calibration is also recommended after the installation of a new or replacement sensor.

^bIf conditions do not permit daily bump testing, the procedure may be done less frequently based on instrument use, potential exposure to gas, and environmental conditions as determined by company policy and local regulatory standards.

^cWhen redundant sensors are operating in DualSense mode, bump testing these sensors may be done less frequently based on your company safety policy.

^dThe instrument performs a self-test during power on. When the instrument remains on, it will complete a self-test during each 12-hour period. The self-test can also be completed on demand through settings.

Note: The use of calibration gases *not* provided by Industrial Scientific may void product warranties and limit potential liability claims.

Biased Sensors

The functionality of biased sensors is dependent on their receipt of continuous power. When their power supply is interrupted, it is their nature to destabilize. This means a biased sensor needs time to restabilize after its power supply is removed or depleted, then restored. Stabilization time varies depending on the sensor type and the length of time it has been without power. Use the information and guidelines supplied below to support the stability of biased sensors installed in the SafeCore Module.

- Install the SafeCore Module into a fully charged Radius Base.
- When the module is installed in the Radius Base, its biased sensors will be powered by the base's rechargeable battery pack regardless of whether the Radius BZ1 is powered on. If the *base's* battery pack charge is depleted, the sensors will draw power from the *module's* backup battery. See also [Care and Storage](#) regarding the battery pack and module's backup battery.

- When the module is *not* installed in a Radius Base, its biased sensors will be powered by the *module's* backup battery to help maintain sensor stability.

When a biased sensor is in use and the Radius BZ1 emits a *low battery* warning or a *low backup battery* warning, complete the steps noted below.

Low battery warning	Low backup battery warning
<ul style="list-style-type: none"> • Charge the Radius Base battery. • Power on the instrument. • Allow up to 24 hours for the biased sensor to stabilize. 	<ul style="list-style-type: none"> • Replace the SafeCore Module's backup battery. • Install the module in a fully charged Radius BZ1. • Power on the instrument. • Allow up to 24 hours for the biased sensor to stabilize.

The power requirements of biased sensors can exceed the setpoint for the low backup battery warning. When a sensor's required power exceeds what the backup battery can supply, the Radius BZ1 will indicate a *sensor error*, so in some cases, the cause of sensor error for a biased sensor may need to be treated as a *low backup battery* warning as described above.

Remote Sampling

When sampling with a motorized pump and sampling line, Industrial Scientific recommends the following.

- Choose the tubing type based on the target gases. If the target gases are known, use Teflon-lined tubing when sampling for these gases: chlorine (Cl₂), chlorine dioxide (ClO₂), hydrogen chloride (HCl), and volatile organic compounds (VOCs). For other known target gases, urethane tubing or Teflon-lined tubing may be used. When the target gases are unknown, use Teflon-lined tubing.
- Know the length of the sample line as it is a factor in determining sampling time. A sample line may consist of tubing, a probe, or a probe and tubing. It should also have an external filter installed at the line's end that will extend into the sample area. Sample-line length is defined as the distance from the external filter opening to the point where the line connects to the pump's inlet. Ensure sample-line length does not exceed the pump's maximum draw.
- Before and after each air sample, perform a test of the full sampling line.
 - Use your thumb to block the end of the sampling line at the external filter. This should cause a pump-fault alarm.
 - Unblock the external filter. After the alarm cycle completes, the pump should resume normal operation.

Note: If a pump fault does *not* occur, check and correct for cracks or other damage, debris, and proper installation in these areas: the sampling line and its connections, the pump's inlet and the external filter at the end of the sampling line.

- Based on sample-line length, calculate the *minimum time* recommended for the air sample to reach the instrument's sensors. As shown below, use a base time of 2 minutes, and add 2 seconds for each 30 cm (1 ') of line length. Watch the display screen for gas readings and, if present, allow them to stabilize to determine the reading.

Table 1.6 Minimum sample time for common sample-line lengths

Sample-line length	Base time (minutes)	+	Sample-line-length factor	=	Minimum sample time (mm:ss)
3.05 m (10')	2 min	+	(10' x 2 s)	=	02:20
6.10 m (20')	2 min	+	(20' x 2 s)	=	02:40
9.15 m (30')	2 min	+	(30' x 2 s)	=	03:00
12.20 m (40')	2 min	+	(40' x 2 s)	=	03:20
15.24 m (50')	2 min	+	(50' x 2 s)	=	03:40
18.29 m (60')	2 min	+	(60' x 2 s)	=	04:00
21.34 m (70')	2 min	+	(70' x 2 s)	=	04:20
24.39 m (80')	2 min	+	(80' x 2 s)	=	04:40
27.45 m (90')	2 min	+	(90' x 2 s)	=	05:00
30.48 m (100')	2 min	+	(100' x 2 s)	=	05:20

Care and Storage

Periodic inspection of the instrument can identify some care and service needs.

- Inspect filters and barriers and replace them if visibly dirty or clogged.
- Connectors, including the SafeCore Module connector, can be cleaned using compressed air.
- The Radius Base can be wiped clean with a damp cloth. Isopropyl alcohol 70% can be used for cleaning, but do not use acetone or other products as they may damage the plastic. Do not use cleaning products that contain silicone as they can contaminate the sensors.

Note: Prolonged exposure to moisture may cause the equipment to experience slight coloration changes. These changes do not impact the performance, integrity, or characteristics of the materials.

- Industrial Scientific recommends that the SafeCore Module be stored in the Radius Base; this will help conserve the module's backup battery, a power source that maintains the module's clock and is needed when biased sensors are installed.

Before long-term storage of the instrument or its base, fully charge the Radius Base factory-installed battery pack. As indicated below, limit the storage duration based on the temperature range of the storage area. These practices will support the unit's ability to receive a charge prior to operation.

Table 1.7 Storage temperature and duration for a fully charged unit

Storage temperature range	Maximum storage time
-20 °C to +5 °C (-4 °F to 41 °F)	up to 21 days
5 °C to 25 °C (41 °F to 77 °F)	up to 90 days
25 °C to 55°C (77 °F to 131 °F)	up to 21 days

Product Information

Instrument Overview

Area Monitoring and Connected Safety

Key Features

Compatibilities

Specifications

Instrument Overview

The Radius® BZ1 Area Monitor is a multigas area monitor (instrument) that can provide readings for up to seven gases simultaneously. With its eighteen compatible sensors, the instrument is capable of monitoring for oxygen and a variety of toxic gases and combustible gases. The Radius BZ1 is used outdoors and indoors for applications that require a worker or worksite perimeter, a fence-line setup, a standalone unit, and confined-space monitoring.

Area Monitoring and Connected Safety

Area monitoring

The Radius BZ1 can operate as a stand-alone gas-detection instrument for area monitoring. To achieve this goal the instrument:

- Alerts workers to actual and potential gas hazards.
- Provides an instructional message option for a variety of specific hazards.

Connected safety

Connected safety from Industrial Scientific provides wireless connections among teammates and cloud-connections for live-monitoring.

Team safety

As part of a LENS™ Wireless group, the Radius BZ1 can operate as a “peer” equipment item. Peer instruments share with one another gas readings, alarms, and other instrument events. This sharing allows workers and their supervisors to learn of hazardous conditions and team members who may be in distress.

Live monitoring

iNet Now live monitoring provides an online, virtual view of “in-field” conditions. From a snapshot of gas readings to the occurrence of potentially hazardous events. The safety team can rapidly dispatch help because they can “see” a situation—the nature and location of a hazard and who may be in danger.

Radius BZ1s are cloud-connected to iNet Now through a compatible gateway when both are operating as LENS group peers.

Note: For applications that include both Radius and Ventis Pro instruments, a smart-device gateway* is also available.

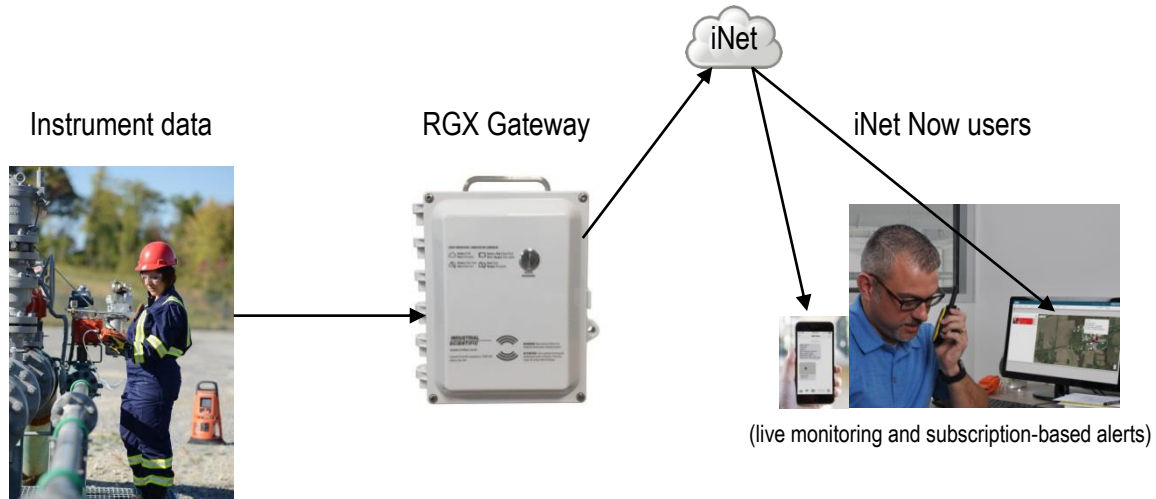

Figure 2.1 Industrial Scientific connected safety system

Key Features

Alarms

Gas alarms

The instrument will alert workers to the following types of alarm events: gas present, STEL, and TWA using two signal options (visual and audible) and up to four distinct audio patterns. These alarms help ensure worker and team-based safety.

Latch alarm

This feature keeps an alarm on after the alarm-causing condition no longer exists. This sustains alarm signals, which encourages workers to check the display screen for gas readings or an instructional message.

Unique alarm action messages

A unique message (e.g., "EVACUATE") can be set for each installed sensor for these events: gas present (alert, low alarm, and high alarm), STEL, and TWA. You can also set a nonalarm, general message that displays during start-up.

Note: Some messages require iNet, DSSAC (Docking Station Software Admin Console), or Accessory Software.

Connected safety

Powerful communications features complement the gas detection capabilities of Industrial Scientific instruments.

LENS Wireless

Use LENS Wireless peer connections to share instrument status (alarms, readings, etc.) among workers. Add a gateway and share with iNet Now the status of up to 25* LENS-connected peers per LENS group.

*The maximum size for each LENS group varies for these specialized applications: 1.) six when a smart-device gateway is in use and 2.) eight when a peer RGX Gateway is used and set to Dynamic Monitoring for plume modeling.

iNet Now

Use iNet Now to virtually “see” the landscape of in-field conditions and the GPS-driven locations of workers in trouble. Set up iNet Now text alerts to be notified of conditions of importance to you.

Power options

Always-on

When enabled with a security code, this option prevents the instrument from being powered off during operation.

Charging

When the instrument is *not* in use, the battery pack can be charged in a nonhazardous environment using the power supply and cord. When in use, maintain battery charge using compatible power-supply accessories from Industrial Scientific (some restrictions apply).

Additional features

DualSense Technology

DualSense® Technology uses two installed, paired sensors of the same type. The instrument processes both sensors' data but displays only a single gas reading. Data are logged for each paired sensor and the derived DualSense "virtual" one. Each sensor operates independently and will operate as a single sensor if its redundant mate fails. This technology reduces the chance of instrument failure due to sensor failure.

Modularity

The Radius BZ1 Area Monitor consists of the *SafeCore® Module* and *Radius Base*.

When installed in the Radius Base, the SafeCore Module serves as the instrument's central processing unit. It houses the sensors, electronics, wireless radio, clock, and clock battery, and the pump (aspirated instruments only). It also stores the data log and settings. The module is in-field replaceable and removable for maintenance and service—tasks that are to be performed in a nonhazardous area.

The Radius Base houses the long-life, extended-run-time, rechargeable battery pack and serves as the user interface. It includes the instrument's user interface buttons, display, and visual and audible alarm-warning-indicator signals.

Quick-status

This feature displays specific information when the instrument is powered-off and while charging the batteries: Radius Base and SafeCore module serial numbers, available battery power, installed sensor types, and other system information.

Compatibilities

Batteries

The battery pack that powers the Radius BZ1 Area Monitor is encased in the Radius Base. It must be charged in a nonhazardous environment using its dedicated power supply and power cord.

Table 2.1 Compatible batteries

Item	Purpose	Use restrictions
Radius Base		
Encased battery pack	Powers the instrument.	Rechargeable only in areas that are known to be nonhazardous.
Power supply and power cord	Charges the encased battery pack.	Use only in areas that are known to be nonhazardous.
SafeCore Module		
Backup battery	Powers the module's clock; powers any installed biased sensors when the SafeCore Module is not installed in a Radius Base or docking station.	Replaceable only in areas that are known to be nonhazardous.

Power supplies

The Radius BZ1 is compatible with three different power-supply accessories from Industrial Scientific, which serve to extend the instrument's operational run time. Each has unique use restrictions and run-time effects. Before using a compatible power supply, read and understand its product manual, which includes a required control drawing.

Table 2.2 Compatible power supplies

Power supply	Orderable part number	Product manual part number
Solar Power Supply (SPS)	18109634 (power supply)	17159773
	IS cable options for Radius-SPS connection:	
	17159898 (standard, 1.52 m [5']) 17156261 (optional, 50 m [54 yd])	
Intrinsically Safe Extended Run Time Power Supply (ISERTPS)	18109516 (power supply)	17158248
	17156261 (IS cable, 50 m [54 yd])	
Extended Run Time Power Supply (ERTPS)	18109388-XA ^b (power-supply kit)	17158358
	17156261 (IS cable, 50 m [54 yd])	

Sensors

As depicted in Figure 2.2, up to six sensors can be installed, each in one or more specific locations inside the SafeCore Module. To support ingress protection, use a compatible plug in place of any uninstalled sensors as shown in locations 4 and 6.

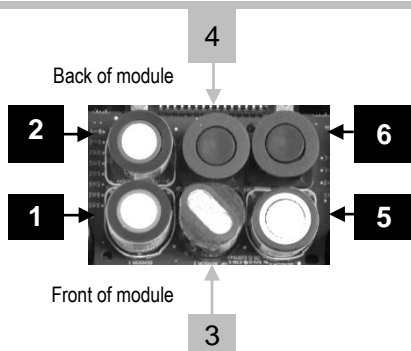

Locations 3 or 4 <i>only</i>	Any location
Carbon Dioxide (CO ₂); 17156650-Q	Ammonia (NH ₃); 17156650-6
Hydrocarbon (HC) IR (Propane); 17156650-P	Carbon Monoxide (CO) ^a ; 17156650-1
LEL (methane) ^a ; 17156650-L	Carbon Monoxide, high range (CO); 17156650-H
LEL (pentane) ^a ; 17156650-K	Carbon Monoxide, low H ₂ interference (CO-low H ₂); 17156650-G
Methane (CH ₄) IR; 17156650-S	Carbon Monoxide and Hydrogen Sulfide (CO/H ₂ S) ^a ; 17156650-J
Volatile Organic Compounds (VOC) PID; 17156650-R	Chlorine (Cl ₂); 17156650-7
Locations 2 or 6 <i>only</i>	Chlorine Dioxide (ClO ₂); 17156650-8
Hydrogen Chloride (HCL); 17156650-A. <i>Only</i> use with the diffusion instrument; not compatible with the aspirated instrument.	Hydrogen (H ₂); 17156650-C
	Hydrogen Cyanide (HCN); 17156650-B
	Hydrogen Sulfide (H ₂ S) ^a ; 17156650-2
	Nitric Oxide (NO) ^b ; 17156650-D
	Nitrogen Dioxide (NO ₂) ^a ; 17156650-4
	Oxygen (O ₂) ^a ; 17156650-3
	Phosphine (PH ₃); 17156650-9
	Sulfur Dioxide (SO ₂) ^a ; 17156650-5

Figure 2.2 Compatible sensors and installation locations

^aDualSense capable. When installing two of the same sensor type for DualSense operation, use the sensor-type compatible locations in these combinations *only*: locations 1 and 2, locations 3 and 4, and locations 5 and 6. It is recommended that sensors operating in DualSense mode have manufacturing dates within three months of each other (see "Mfg. date" YYYY-MM).

^bBiased sensor (see Chapter 1, "Recommended Practices, [Biased Sensors](#)").

Docking station and software

The SafeCore Module is compatible with the DSX™ Docking Station and is supported by iNet or DSSAC software from Industrial Scientific.

Sample tubing kits

Industrial Scientific recommends the use of its Teflon-lined tubing kit (part number 18109206) when sampling for these gases, which are susceptible to absorption by other types of tubing materials: Chlorine (Cl₂), Chlorine Dioxide (ClO₂), Hydrogen Chloride (HCl), and Volatile Organic Compounds (VOCs). For other target gases, the Urethane tubing kit (part number 18109207) or the Teflon-lined tubing kit can be used.

Specifications

Instrument

The Radius BZ1 takes gas readings every second and records readings-related data at its settable interval. Data are stored in the instrument data log, which has these characteristics:

- Capacity for approximately 90 days of data for a unit that has six installed sensors and is set to record data every ten seconds.
- Data storage for up to 60 alarm events, 30 error events, and 250 manual calibrations and bump tests.

Additional instrument specifications are provided below.

Table 2.3 Instrument specifications

Item	Description
Display	11.2 cm (4.4 ") monochrome LCD
User interface buttons	Three: left button, power button, and right button
Alarms ^a	Visual: red and blue LEDs Audible: 108 dB at a distance of 1 m (3.3 ')
Dimensions	29 x 29 x 55 cm (11.4 x 11.4 x 21.6 ")
Weight	7.5 kg (16.5 lb)
Ingress protection	IP66
Pump	300-415 cc per minute flow rate With 0.3175 cm (0.125 ") inside diameter sample tubing, sustains a continuous sample draw for up to 30.48 m (100 ')
Operating temperature range ^b	-20 °C to +55 °C (-4 °F to +131 °F)
Operating humidity range ^b	15–95% relative humidity (RH) noncondensing (continuous)
Storage temperature range ^c	-20 °C to +55 °C (-4 °F to +131 °F)
Pressure range	1 atm ± 0.2 atm

^aMay vary based on in-field conditions.

^bSensor temperature and humidity ranges may differ from those of the instrument (see "Table 2.5 Sensor specifications").

^cMaximum storage duration is based on the temperature of the storage environment (see "Table 1.7 Storage temperature and duration for a fully charged unit").

Batteries

Provided below are battery specifications, which include run time, charge time, charging temperature requirements, and expected lifetime.

Table 2.4 Battery specifications

	Battery	
	Radius Base battery pack	SafeCore Module battery
Battery type	Nickel Metal Hydride	Lithium Thionyl Chloride (Li-SOCl ₂)
Battery lifetime	2 years	2+ years ^c
Run time ^a	168 hours	—
Battery charge time	Less than 8 hours	—
Charging cycles	1000 cycles	—
Battery charge temperature ^b	0 – 50 °C (32 – 122 °F)	—
Nominal voltage	6.0 VDC	3.6 VDC
Nominal capacity	12.0 Ah	1.1 Ah
Nominal power	72.0 Wh	4.0 Wh

^aApproximate run time for a fully charged battery powering a diffusion unit that is operating at room temperature (25 °C [77 °F]) with CO, H₂S, O₂, and LEL sensors installed, has the wireless option enabled, and experiences 10 minutes of high alarm per day.

^bBattery charging is suspended in temperatures below 0 °C (32 °F) and above 50 °C (122 °F).

^cThe use of biased sensors may decrease the battery lifetime.

Sensors

Provided below are specifications for each sensor, which include properties, installation locations, operating conditions, and performance data.

Table 2.5 Sensor specifications, Ammonia
 NH₃ for SafeCore Module; part number 17156650-6

Property	Value
Category	Toxic and combustible
Technology	Electrochemical
DualSense capable	No
Installation location	Any
Operating conditions	
Temperature range ^a	-20 to +40 °C (-4 to +104 °F)
RH range ^a	15–95%
Performance	
<i>Sensitivity</i>	
Measurement range	0–500 ppm
Measurement resolution	1 ppm
<i>Accuracy^b</i>	
Calibration gas and concentration	50 ppm NH ₃
Accuracy at time and temperature of calibration	± 11% (0–50 ppm) ± 13% (51–500 ppm)
Accuracy over sensor's full temperature range	±15%
<i>Response Time</i>	
T50	26s
T90	85s

^aDuring continuous operation.

^bApply when the instrument is calibrated using the stated calibration gas and concentration; unless otherwise stated, accuracy is equal to the stated percentage or one unit of resolution, whichever is greater.

Table 2.6 Sensor specifications, Carbon Dioxide
CO₂ for SafeCore Module; part number 17156650-Q

Property	Value
Category	Toxic
Technology	Infrared
DualSense capable	No
Installation location	3 or 4
Operating conditions	
Temperature range ^a	-20 to +50 °C (-4 to +122 °F)
RH range ^a	0–95%
Performance	
<i>Sensitivity</i>	
Measurement range	0–5% vol
Measurement resolution	0.01% vol
<i>Accuracy^b</i>	
Calibration gas and concentration	2.5% vol CO ₂
Accuracy at time and temperature of calibration	± 0.1% vol or 10% of reading (whichever is greater)
Accuracy over sensor's full temperature range	± 10.0%
<i>Response Time</i>	
T50	25 s
T90	60 s

^aDuring continuous operation.

^bApply when the instrument is calibrated using the stated calibration gas and concentration; unless otherwise stated, accuracy is equal to the stated percentage or one unit of resolution, whichever is greater.

Table 2.7 Sensor specifications, Carbon Monoxide
CO for SafeCore Module; part number 17156650-1

Property	Value
Category	Toxic
Technology	Electrochemical
DualSense capable	Yes
Installation location	Any
Operating conditions	
Temperature range ^a	-20 to +50 °C (-4 to +122 °F)
RH range ^a	0-95%
Performance	
<i>Sensitivity</i>	
Measurement range	0-1500 ppm
Measurement resolution	1 ppm
<i>Accuracy^b</i>	
Calibration gas and concentration	100 ppm CO
Accuracy at time and temperature of calibration	± 5%
Accuracy over sensor's full temperature range	± 15%
<i>Response Time</i>	
T50	8 s
T90	19 s

^aDuring continuous operation.

^bApply when the instrument is calibrated using the stated calibration gas and concentration; unless otherwise stated, accuracy is equal to the stated percentage or one unit of resolution, whichever is greater.

Table 2.8 Sensor specifications, Carbon Monoxide (high range)

CO High for SafeCore Module; part number 17156650-H

Property	Value
Category	Toxic
Technology	Electrochemical
DualSense capable	No
Installation location	Any
Operating conditions	
Temperature range ^a	-20 to +50 °C (-4 to +122 °F)
RH range ^a	15–90%
Performance	
<i>Sensitivity</i>	
Measurement range	0–9999 ppm
Measurement resolution	1 ppm
<i>Accuracy^b</i>	
Calibration gas and concentration	100 ppm CO
Accuracy at time and temperature of calibration	± 6.0%
Accuracy over sensor's full temperature range	± 15.0%
<i>Response Time</i>	
T50	9 s
T90	18 s

^aDuring continuous operation.

^bApply when the instrument is calibrated using the stated calibration gas and concentration; unless otherwise stated, accuracy is equal to the stated percentage or one unit of resolution, whichever is greater.

Table 2.9 Sensor specifications, Carbon Monoxide with low Hydrogen cross-sensitivity
CO/H₂ Low for SafeCore Module; part number 17156650-G

Property	Value
Category	Toxic
Technology	Electrochemical
DualSense capable	Yes
Installation location	Any
Operating conditions	
Temperature range ^a	-20 to +50 °C (-4 to +122 °F)
RH range ^a	15–90%
Performance	
<i>Sensitivity</i>	
Measurement range	0–1000 ppm
Measurement resolution	1 ppm
<i>Accuracy^b</i>	
Calibration gas and concentration	100 ppm CO
Accuracy at time and temperature of calibration	± 6.0%
Accuracy over sensor's full temperature range	± 15.0%
<i>Response Time</i>	
T50	9s
T90	20s

^aDuring continuous operation.

^bApply when the instrument is calibrated using the stated calibration gas and concentration; unless otherwise stated, accuracy is equal to the stated percentage or one unit of resolution, whichever is greater.

Table 2.10 Sensor specifications, Carbon Monoxide and Hydrogen Sulfide
CO and H₂S for SafeCore Module; part number 17156650-J

Property	Value	
Category	Toxic	
Technology	Electrochemical	
DualSense capable	Yes	
Installation locations	Any	
Operating conditions	CO	H ₂ S
Temperature range ^a	-20 to +50 °C (-4 to +122 °F)	-20 to +55°C (-4 to +131°F)
RH range ^a	15–90%	15–95%
Performance		
<i>Sensitivity</i>		
Measurement range	0–150 0 ppm	0–500 ppm
Measurement resolution	1 ppm	0.1 ppm
<i>Accuracy^b</i>		
Calibration gas and concentration	100 ppm CO	25 ppm H ₂ S
Accuracy at time and temperature of calibration	± 5%	± 9%
Accuracy over sensor's full temperature range	± 15%	± 15%
<i>Response Time</i>		
T50	13 s	11 s
T90	33 s	21 s

^aDuring continuous operation.

^bApply when the instrument is calibrated using the stated calibration gas and concentration; unless otherwise stated, accuracy is equal to the stated percentage or one unit of resolution, whichever is greater.

Table 2.11 Sensor specifications, Chlorine
Cl₂ for SafeCore Module; part number 17156650-7

Properties	Value
Category	Toxic
Technology	Electrochemical
DualSense capable	No
Installation location	Any
Operating conditions	
Temperature range ^a	-20 to +50 °C (-4 to +122 °F)
RH range ^a	15-90%
Performance	
<i>Sensitivity</i>	
Measurement range	0-50 ppm
Measurement resolution	0.1 ppm
<i>Accuracy^b</i>	
Calibration gas and concentration	10 ppm Cl ₂
Accuracy at time and temperature of calibration	± 15.0% or 0.3 ppm (0–10.0 ppm) 0–20.0% (10.1–50.0 ppm)
Accuracy over sensor's full temperature range	± 15.0% (-20 to +40 °C) ± 25.0% (41–50 °C)
<i>Response Time</i>	
T50	7 s
T90	43 s

^aDuring continuous operation.

^bApply when the instrument is calibrated using the stated calibration gas and concentration; unless otherwise stated, accuracy is equal to the stated percentage or one unit of resolution, whichever is greater.

Table 2.12 Sensor specifications, Chlorine Dioxide
 CLO₂ for SafeCore Module; part number 17156650-8

Properties	Value
Category	Toxic
Technology	Electrochemical
DualSense capable	No
Installation location	Any
Operating conditions	
Temperature range ^a	-20 to +40 °C (-4 to +104 °F)
RH range ^a	15–90%
Performance	
<i>Sensitivity</i>	
Measurement range	0–1 ppm
Measurement resolution	0.01 ppm
<i>Accuracy^b</i>	
Calibration gas and concentration	1 ppm CLO ₂
Accuracy at time and temperature of calibration	± 0.05 ppm or ± 10% of reading, whichever is greater
Accuracy over sensor's full temperature range	± 20%
<i>Response Time</i>	
T50	10 s
T90	70 s

^aDuring continuous operation.

^bApply when the instrument is calibrated using the stated calibration gas and concentration; unless otherwise stated, accuracy is equal to the stated percentage or one unit of resolution, whichever is greater.

Table 2.13 Sensor specifications, Hydrogen
H₂ for SafeCore Module; part number 17156650-C

Property	Value
Category	Toxic
Technology	Electrochemical
DualSense capable	No
Installation location	Any
Operating conditions	
Temperature range ^a	-20 to +50 °C (-4 to +122 °F)
RH range ^a	15-90%
Performance	
<i>Sensitivity</i>	
Measurement range	0-2000 ppm
Measurement resolution	1 ppm
<i>Accuracy^b</i>	
Calibration gas and concentration	100 ppm H ₂
Accuracy at time and temperature of calibration	± 6%
Accuracy over sensor's full temperature range	± 15%
<i>Response Time</i>	
T50	40 s
T90	90 s

^aDuring continuous operation.

^bApply when the instrument is calibrated using the stated calibration gas and concentration; unless otherwise stated, accuracy is equal to the stated percentage or one unit of resolution, whichever is greater.

Table 2.14 Sensor specifications, Hydrogen Chloride
HCL for SafeCore Module; part number 17156650-A^a

Property	Value
Category	Toxic
Technology	Electrochemical
DualSense capable	No
Installation location	2 or 6 (diffusion instrument only)
Operating conditions	
Temperature range ^b	-20 to +40 °C (-4 to +104 °F)
RH range ^b	15–90%
Performance	
<i>Sensitivity</i>	
Measurement range	0-30 ppm
Measurement resolution	0.1 ppm
<i>Accuracy^c</i>	
Calibration gas and concentration	10 ppm HCL
Accuracy at time and temperature of calibration	± 22% or 1 ppm, whichever is greater (0–10 ppm) ± 45% (10.1–30 ppm)
Accuracy over sensor's full temperature range	± 15%
<i>Response Time</i>	
T50	47s
T90	96s

^aCompatible with the diffusion instrument *only*; *not* compatible with the aspirated instrument.

^bDuring continuous operation.

^cApply when the instrument is calibrated using the stated calibration gas and concentration.

Table 2.15 Sensor specifications, Hydrogen Cyanide
 HCN for SafeCore Module; part number 17156650-B

Property	Value
Category	Toxic
Technology	Electrochemical
DualSense capable	No
Installation location	Any
Operating conditions	
Temperature range ^a	-20 to +40 °C (-4 to +104 °F)
RH range ^a	15–90%
Performance	
<i>Sensitivity</i>	
Measurement range	0.4–30 ppm
Measurement resolution	0.1 ppm
<i>Accuracy^b</i>	
Calibration gas and concentration	10 ppm HCN
Accuracy at time and temperature of calibration	± 10%
Accuracy over sensor's full temperature range	± 15%
<i>Response Time</i>	
T50	14 s
T90	59 s

^aDuring continuous operation.

^bApply when the instrument is calibrated using the stated calibration gas and concentration; unless otherwise stated, accuracy is equal to the stated percentage or one unit of resolution, whichever is greater.

Table 2.16 Sensor specifications, Hydrogen Sulfide
H₂S for SafeCore Module; part number 17156650-2

Properties	Value
Category	Toxic
Technology	Electrochemical
DualSense capable	Yes
Installation location	Any
Operating conditions	
Temperature range ^a	-20 to +50 °C (-4 to +122 °F)
RH range ^a	15-90%
Performance	
<i>Sensitivity</i>	
Measurement range	0–500 ppm
Measurement resolution	0.1 ppm
<i>Accuracy^b</i>	
Calibration gas and concentration	25 ppm H ₂ S
Accuracy at time and temperature of calibration	± 5% (0–200 ppm) ± 7% (201–500 ppm)
Accuracy over sensor's full temperature range	± 15%
<i>Response Time</i>	
T50	7 s
T90	14 s

^aDuring continuous operation.

^bApply when the instrument is calibrated using the stated calibration gas and concentration; unless otherwise stated, accuracy is equal to the stated percentage or one unit of resolution, whichever is greater.

Table 2.17 Sensor specifications, Hydrocarbon, IR (Propane)

HC IR (Propane) for SafeCore Module; part number 17156650-P

Property	Value
Category	Combustible
Technology	Infrared
DualSense capable	No
Installation location	3 or 4
Operating conditions	
Temperature range ^a	-20 to +50 °C (-4 to +122 °F)
RH range ^a	0–95%
Performance	
<i>Sensitivity</i>	
Measurement range	0–100% LEL
Measurement resolution	1% LEL
<i>Accuracy^b</i>	
Calibration gas and concentration	50% LEL Propane
Accuracy at time and temperature of calibration	± 1% LEL or ± 10% of reading, whichever is greater
Accuracy over sensor's full temperature range	± 15%
<i>Response Time</i>	
T50	25 s
T90	51 s

^aDuring continuous operation.

^bApply when the instrument is calibrated using the stated calibration gas and concentration; unless otherwise stated, accuracy is equal to the stated percentage or one unit of resolution, whichever is greater.

Table 2.18 Sensor specifications, LEL Methane

LEL Methane for SafeCore Module; part number 17156650-L

Property	Value
Category	Combustible
Technology	Catalytic
DualSense capable	Yes
Installation location	3 or 4
Operating conditions	
Temperature range ^a	-20 to +55 °C (-4 to +131 °F)
RH range ^a	15–95%
Performance	
<i>Sensitivity</i>	
Measurement range	0–100% LEL
Measurement resolution	1% LEL
<i>Accuracy^b</i>	
Calibration gas and concentration	50% LEL
Accuracy at time and temperature of calibration	± 5%
Accuracy over sensor's full temperature range	± 15%
<i>Response Time</i>	
T50	10 s
T90	30 s

^aDuring continuous operation.

^bApply when the instrument is calibrated using the stated calibration gas and concentration; unless otherwise stated, accuracy is equal to the stated percentage or one unit of resolution, whichever is greater.

Table 2.19 Sensor specifications, LEL Pentane

LEL Pentane for SafeCore Module; part number 17156650-K

Property	Value
Category	Combustible
Technology	Catalytic
DualSense capable	Yes
Installation location	3 or 4
Operating conditions	
Temperature range ^a	-20 to +55 °C (-4 to +131 °F)
RH range ^a	15–95%
Performance	
<i>Sensitivity</i>	
Measurement range	0–100% LEL
Measurement resolution	1% LEL
<i>Accuracy^b</i>	
Calibration gas and concentration	25% LEL
Accuracy at time and temperature of calibration	± 5%
Accuracy over sensor's full temperature range	± 15%
<i>Response Time</i>	
T50	10 s
T90	30 s

^aDuring continuous operation.

^bApply when the instrument is calibrated using the stated calibration gas and concentration; unless otherwise stated, accuracy is equal to the stated percentage or one unit of resolution, whichever is greater.

Table 2.20 Sensor specifications, Methane, IR
 CH4 IR for SafeCore Module; part number 17156650-S

Property	Value
Category	Combustible
Technology	Infrared
DualSense capable	No
Installation location	3 or 4
Operating conditions	
Temperature range ^a	-20 to +50 °C (-4 to +122 °F)
RH range ^a	0–95%
Performance	
<i>Sensitivity</i>	
Measurement range	0–100% LEL
Measurement resolution	1% LEL
<i>Accuracy^b</i>	
Calibration gas and concentration	50% LEL Methane
Accuracy at time and temperature of calibration	± 1% LEL or ± 10% of reading, whichever is greater
Accuracy over sensor's full temperature range	± 15%
<i>Response Time</i>	
T50	15 s
T90	31 s

^aDuring continuous operation.

^bApply when the instrument is calibrated using the stated calibration gas and concentration; unless otherwise stated, accuracy is equal to the stated percentage or one unit of resolution, whichever is greater.

Table 2.21 Sensor specifications, Nitric Oxide
NO for SafeCore Module; part number 17156650-D

Property	Value
Category	Toxic
Technology	Electrochemical
DualSense capable	No
Installation location	Any
Operating conditions	
Temperature range ^a	-20 to +50 °C (-4 to +122 °F)
RH range ^a	15-90%
Performance	
<i>Sensitivity</i>	
Measurement range	0-1000 ppm
Measurement resolution	1 ppm
<i>Accuracy^b</i>	
Calibration gas and concentration	25 ppm NO
Accuracy at time and temperature of calibration	± 10% (0–100 ppm) ± 16% (101–1000 ppm)
Accuracy over sensor's full temperature range	± 15%
<i>Response Time</i>	
T50	10 s
T90	28 s

^aDuring continuous operation.

^bApply when the instrument is calibrated using the stated calibration gas and concentration; unless otherwise stated, accuracy is equal to the stated percentage or one unit of resolution, whichever is greater.

Table 2.22 Sensor specifications, Nitrogen Dioxide
 NO₂ for SafeCore Module; part number 17156650-4

Property	Value
Category	Toxic
Technology	Electrochemical
DualSense capable	Yes
Installation location	Any
Operating conditions	
Temperature range ^a	-20 to +50 °C (-4 to +122 °F)
RH range ^a	15–90%
Performance	
<i>Sensitivity</i>	
Measurement range	0–150 ppm
Measurement resolution	0.1 ppm
<i>Accuracy^b</i>	
Calibration gas and concentration	25 ppm NO ₂
Accuracy at time and temperature of calibration	± 5% (0–50 ppm) -5 to +18% (51–150 ppm)
Accuracy over sensor's full temperature range	± 15%
<i>Response Time</i>	
T50	7 s
T90	17 s

^aDuring continuous operation.

^bApply when the instrument is calibrated using the stated calibration gas and concentration; unless otherwise stated, accuracy is equal to the stated percentage or one unit of resolution, whichever is greater.

Table 2.23 Sensor specifications, Oxygen

O₂ for SafeCore Module; part number 17156650-3

Property	Value
Category	Oxygen
Technology	Electrochemical
DualSense capable	Yes
Installation location	Any
Operating conditions	
Temperature range ^a	-20 to +55 °C (-4 to +131 °F)
RH range ^a	5–95%
Performance	
<i>Sensitivity</i>	
Measurement range	0–30% vol
Measurement resolution	0.1% vol
<i>Accuracy^b</i>	
Calibration gas and concentration	20.9% vol O ₂
Accuracy at time and temperature of calibration	± 0.5% vol (0.0–25.0%) ± 1.2% vol (25.1–30.0%)
Accuracy over sensor's full temperature range	± 0.8% vol
<i>Response Time</i>	
T50	8 s
T90	16 s

^aDuring continuous operation.

^bApply when the instrument is calibrated using the stated calibration gas and concentration; unless otherwise stated, accuracy is equal to the stated percentage or one unit of resolution, whichever is greater.

Table 2.24 Sensor specifications, Phosphine

PH₃ for SafeCore Module; part number 17156650-9

Property	Value
Category	Toxic
Technology	Electrochemical
DualSense capable	No
Installation location	Any
Operating conditions	
Temperature range ^a	-20 to +50 °C (-4 to +122 °F)
RH range ^a	15–95%
Performance	
<i>Sensitivity</i>	
Measurement range	0–5 ppm
Measurement resolution	0.01 ppm
<i>Accuracy^b</i>	
Calibration gas and concentration	1 ppm PH ₃
Accuracy at time and temperature of calibration	± 6% or ± 0.1 ppm, whichever is greater
Accuracy over sensor's full temperature range	± 15%
<i>Response Time</i>	
T50	8 s
T90	18 s

^aDuring continuous operation.

^bApply when the instrument is calibrated using the stated calibration gas and concentration; unless otherwise stated, accuracy is equal to the stated percentage or one unit of resolution, whichever is greater.

Table 2.25 Sensor specifications, Sulfur Dioxide
 SO₂ for SafeCore Module; part number 17156650-5

Property	Value
Category	Toxic
Technology	Electrochemical
DualSense capable	Yes
Installation location	Any
Operating conditions	
Temperature range ^a	-20 to +50 °C (-4 to +122 °F)
RH range ^a	15-90%
Performance	
<i>Sensitivity</i>	
Measurement range	0-150 ppm
Measurement resolution	0.1 ppm
<i>Accuracy^b</i>	
Calibration gas and concentration	10 ppm SO ₂
Accuracy at time and temperature of calibration	± 8%
Accuracy over sensor's full temperature range	± 15%
<i>Response Time</i>	
T50	8 s
T90	20 s

^aDuring continuous operation.

^bApply when the instrument is calibrated using the stated calibration gas and concentration; unless otherwise stated, accuracy is equal to the stated percentage or one unit of resolution, whichever is greater.

Table 2.26 Sensor specifications, Volatile Organic Compounds

VOC for SafeCore Module; part number 17156650-R

Property	Value
Category	Toxic
Technology	PID (10.6 eV)
DualSense capable	No
Installation location	3 or 4
Operating conditions	
Temperature range ^a	-20 to +50 °C (-4 to +122 °F)
RH range ^a	0–90%
Performance	
<i>Sensitivity</i>	
Measurement range	0–2000 ppm
Measurement resolution	0.1 ppm
<i>Accuracy^b</i>	
Calibration gas and concentration	100 ppm Isobutylene
Accuracy at time and temperature of calibration	± 7% (0–600 ppm) ± 13% (601–1000 ppm)
Accuracy over sensor's full temperature range	-22–0% (1001–2000 ppm)
<i>Response Time</i>	
T50	10 s
T90	15 s

^aDuring continuous operation.

^bApply when the instrument is calibrated using the stated calibration gas and concentration; unless otherwise stated, accuracy is equal to the stated percentage or one unit of resolution, whichever is greater.

Getting Started

Unpacking

Hardware Overview

Setup

Display Overview

Unpacking

A shipment may include the items listed below in Table 3.1. Each item should be accounted for during the unpacking process. If any item is missing or appears to have been damaged, contact Industrial Scientific (see back cover for [Contact Information](#)) or an authorized distributor of Industrial Scientific products.

Table 3.1 Package contents

Quantity	Item	Details
1 as ordered	Radius BZ1 Base	—
1 as ordered	SafeCore® Module	Diffusion or aspirated.
1	Pump inlet water barrier	Aspirated SafeCore Modules only.
1	Hand tool	Screwdriver set that includes T30 and T10 torx bits.
1	Charging power supply and cord	The power-cord type is based on the order destination. It is suited for only one of the following outlet types: NA, EU, AUS, or UK. Not included with SafeCore Module-only orders.
1	Calibration cup	Diffusion SafeCore Modules only.
1	Calibration tubing	60.96 cm (2') of urethane tubing; 4.762 mm (3/16") inside diameter. Not included in Radius Base-only orders.
1	<i>Final Inspection & Test Report</i>	Includes information ^a about the instrument, the installed sensors, and factory calibration. Not included in Radius Base-only orders.
1	<i>Warranty Benefits Booklet</i>	—
1	<i>Quick Start</i>	—

^aAt the time of shipment.

Hardware Overview

The main hardware components of the Radius® BZ1 Area Monitor are identified below in Figure 3.1.A and Figure 3.1.B (front view and back view, respectively). The front view features the diffusion instrument and shows the gas path, which leads to the sensor ports. The aspirated unit, as shown in the back view, features a pump inlet that draws air into the unit.



Figure 3.1.A Hardware overview Radius BZ1 (front view; diffusion)

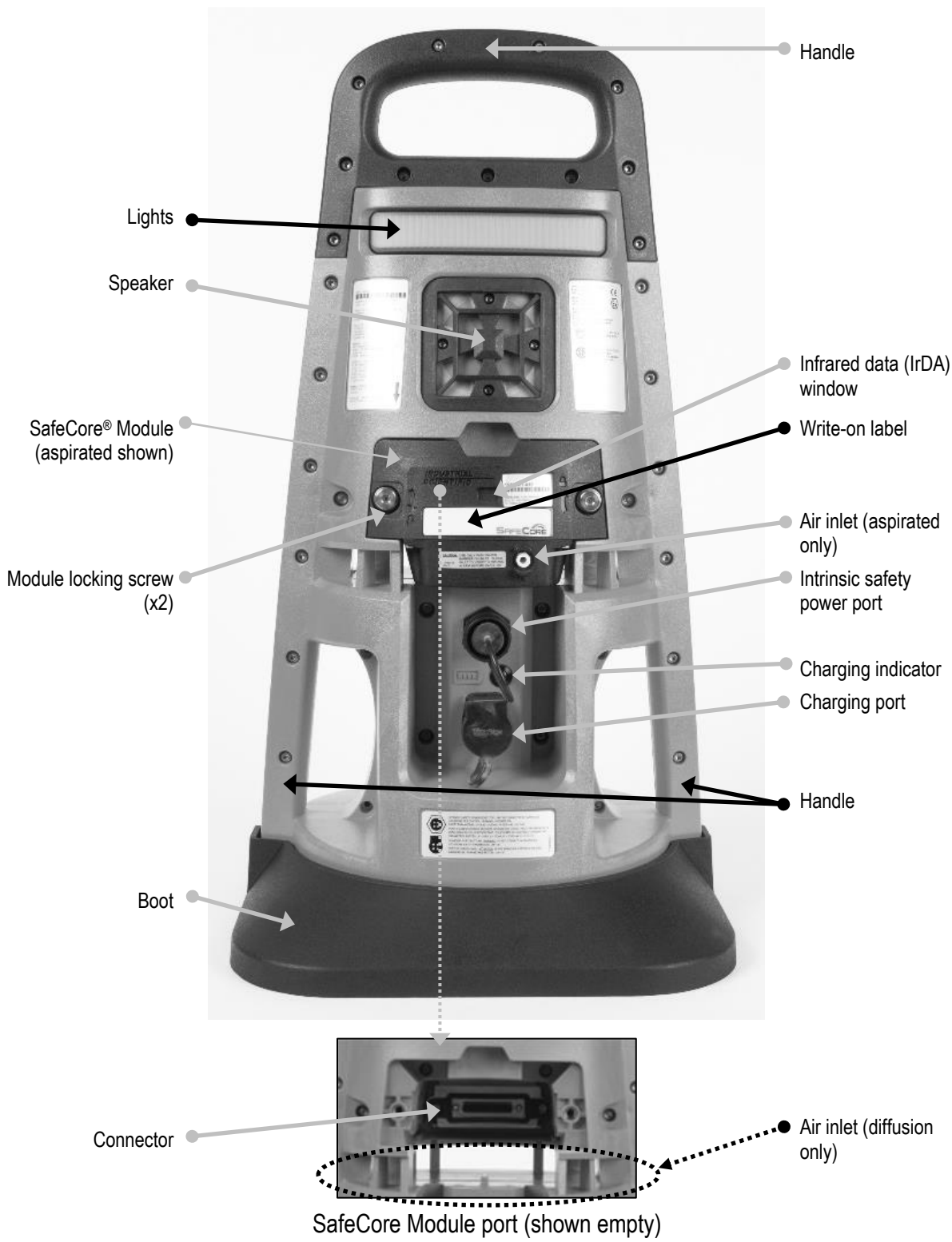
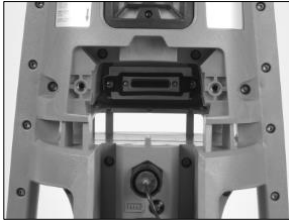

Figure 3.1.B Hardware overview Radius BZ1 (back view; aspirated)

Setup

Use the supplied screwdriver set to prepare the instrument for operation as described below in Figure 3.2.



On the back of the Radius Base, locate the SafeCore Module port.



Slide the module straight into its port. Push firmly to support the connection of the module to the base. Use care not to damage the module's connector pins. When installed correctly, there will be slight connection impact and the module edge will be flush with the surface of the base.



Using the supplied screwdriver set, tighten both module screws. Push the screw into the borehole; its spring will compress. Turn the screw clockwise; tighten until the red indicator surrounding the borehole is no longer visible.



From the display screen on the front of the instrument, peel back the plastic film and discard it.

For aspirated units only



Connect the water stop to the pump inlet port; turn clockwise to tighten.



Attach one end of the sample tubing to the external filter that is attached to the pump inlet (above left).



Attach the other end to a compatible water stop (right).

At each end, push on the tubing to ensure the connecting part is fully inserted into the tubing (approximately 0.635 cm [.25"]).

Figure 3.2 Setup

Display Overview

As shown below, the main portion of the display is dedicated to *gas readings* information. Above the gas readings area is a *status bar* and below it a *navigation bar*. Status symbols and information display in both bars; the navigation bar also displays control symbols and instructional text.

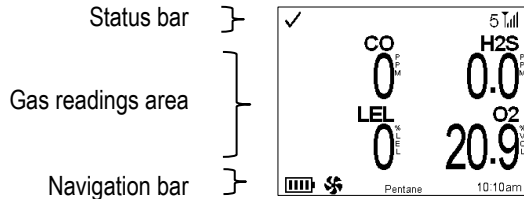
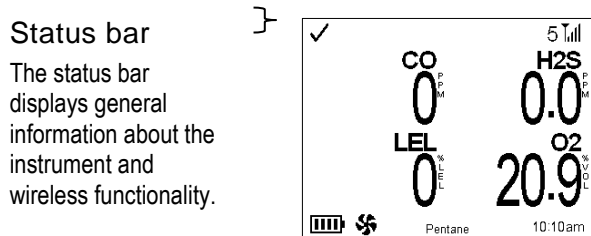

Figure 3.3 Display screen elements that may be seen during instrument operation. These elements include symbols, numbers, abbreviations, and text that the instrument uses to communicate with users.



Instrument and wireless status symbols

Instrument status



The checkmark indicates the instrument is operational.



The warning symbol may appear in combination with text or symbols to identify a specific issue.

LENS Wireless status



Indicates the LENS Wireless group peer count and the group's signal quality.

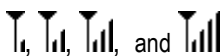

The LENS group signal quality is shown here in order from weakest to strongest.



The wireless radio is *not* functioning—LENS features are not available.



The wireless radio is set to "off"—LENS features are not available.

iNet Now status



The instrument is wirelessly connected to iNet; it is available for live monitoring by iNet Now users.



The instrument is *not* wirelessly connected to iNet; it is unavailable for live monitoring by iNet Now users.

No cloud

The instrument's firmware version, settings, or LENS Wireless status make it unavailable for live monitoring by users of iNet Now.

Other symbols

Tank 1

When the display area or navigation bar features information about a peer instrument, this text identifies that instrument. If the peer instrument does not have an assigned user such as "Tank 1", its serial number displays in place of the user assignment.



Identifies a peer instrument as a Radius BZ1.



Identifies a peer instrument as a Ventis™ Pro.

Gas readings area

This area displays gas-readings information, alarm details, and sensor status messages (e.g., calibration due symbol).

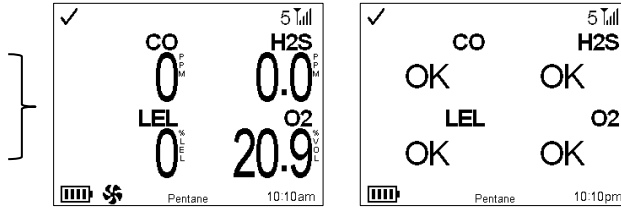

Numeric view

Text view

Gas readings



Gas, current reading, and unit of measure.

Event symbols (gas-related)

- OR** Gas present, positive over-range alarm.
- Gas present, high alarm.
- Gas present, low alarm.
- STEL** Short-term exposure limit (STEL) alarm.
- TWA** Time-weighted average (TWA) alarm.
- Alarm is latched.

Sensor status symbols

- The warning symbol may appear in combination with text or symbols to identify a specific issue.
- OFF** The indicated sensor has been set to off and is not operational.
- The indicated sensor is part of a DualSense pair.

Utility symbols

- and Maintenance due (bump test shown).
- and Maintenance due (calibration shown).

During operation, the navigation bar generally provides information. Shown here is the battery status, the LEL correlation factor, and the time of day (12-hour format).

The navigation bar also displays peer alarms and details about those alarms (event, gas reading, and instrument). At other times, it displays symbols (or text); each displayed option is controlled by the button directly below it.

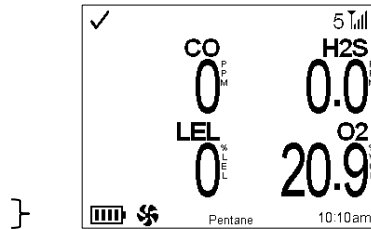

Navigation bar

Network information

Tank 3

Identifies an instrument in the LENS peer group that may be experiencing an alarm or a group-peer connection issue. A symbol next to the device number will indicate the issue. *Note:* If no user (Tank 3 shown here) is assigned, the instrument's serial number will display.

Other symbols



The warning symbol may appear in combination with text or symbols to identify a specific issue.



Displays instead of the gas reading for a sensor that is biasing. Once biasing has finished, or after 15 minutes, the gas reading will display. Can also indicate a procedure or instrument self-adjustment is in progress.



The installed SafeCore Module is aspirated.



The battery's level of charge is between 76 and 100%.



The battery's level of charge is between 51 and 75%.



The battery's level of charge is between 26 and 50%.



The battery's level of charge is less than or equal to 25%.



The battery's level of charge is approaching a critically low level.



A power supply is in use.

11:56am

The time of day (12-hour format shown) – alternates with the ambient temperature.

26° C

Ambient temperature displayed in degrees Celsius – alternates with the time of day.

Control symbols and Instructional text



Scroll an options list.



Make a selection, start a process, or answer affirmatively.



Instructional text.

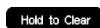

Figure 3.3 Display overview (operational instrument)

Settings

Guidelines

Accessing Settings

Settings Overview

Display Overview (settings)

Working in Settings

Reviewing and Editing Settings

Guidelines

Radius® BZ1 Area Monitor settings that can be adjusted manually through the instrument are described in this manual. These and other settings can also be adjusted through compatible Industrial Scientific docking stations that are supported by iNet® and DSSAC.

Note: Any changes made *manually* will be *overridden* when the SafeCore® Module is *docked*.

Only qualified personnel should access and adjust instrument settings; this person is referred to below as the "safety specialist." To help guard against unintended access by nonqualified personnel, settings can be protected by a security code.

Accessing Settings

Radius BZ1 settings, which are stored in the SafeCore Module, can be accessed at any time during operation by simultaneously pressing and holding the instrument's left and right buttons. As shown below, if the security-code screen is activated, settings *are* protected and you must enter the instrument's security code to access settings. If the value entered matches the security-code setting, the settings menu will display; otherwise, access to settings will be denied and the instrument will display its home screen.

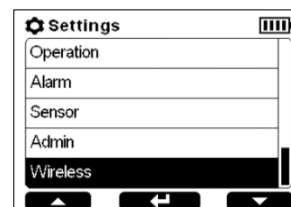
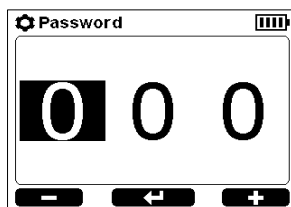

To access the settings, press and hold the left and the right buttons simultaneously.

- | | | | | | |
|---|-----------------------------------|--------------------------------------|---------------------------------|-------------------------------------|-----------------------------------|
| ■ | ⏻ | ■ | ■ | ⏻ | ■ |
| Decrease
the
highlighted
value | Enter the
highlighted
value | Increase the
highlighted
value | Move the
highlight bar
up | Select the
highlighted
option | Move the
highlight
bar down |

When working in settings, the instrument will wait approximately 30 seconds between button presses; when no button is pressed, it will exit the current setting screen and revert to the prior display screen. If that is the home screen, simultaneously press and hold the left and right buttons to re-enter settings.

Settings Overview

Instrument settings are organized by topic. This allows the safety specialist to first choose the topic of interest, such as wireless, then review and optionally adjust each setting within that topic. The settings topics are described below in Table 4.1.

Table 4.1 Settings overview

Topic	Description
Maintenance	View general instrument information. Perform utilities—routine maintenance such as bump testing. View and optionally change an instrument's current user and site assignments.
Start-up	Control what the instrument operator can access during the power-on process.
Operation	Control what the instrument operator can access during operation.
Alarm	Control how the instrument will behave during alarms and some warnings; view and optionally edit current alarm setpoint values.
Sensor	Control which sensors are enabled or disabled for gas detection. Optionally edit calibration gas settings, set the LEL sensor's correlation factor, or set the PID sensor's response factor.
Admin (Administration)	Control the ways in which an instrument will interact with its user: set a security code, the display-screen language, a confidence indicator, and more. Set reminders for utilities and related values such as dock due interval.
Wireless	Control LENS Wireless functionality, allow or disallow instrument data transmission to iNet for live-monitoring of the unit by users of iNet Now, and set GPS options.

Display Overview (settings)

As shown below, the main portion of the display is where editing takes place. Above the *editing area* is a *status bar* and below it a *navigation bar*. The status bar is used to indicate the setting menu or the setting being edited. The navigation bar features control symbols.

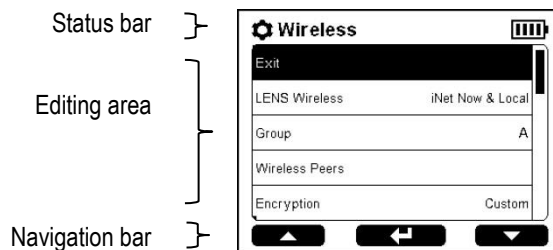
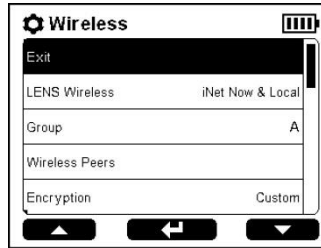

Figure 4.1 documents display screen elements that may display in settings. These elements include symbols, text, numbers, and abbreviations that allow the safety specialist to easily edit settings.

Status bar

When working in settings, the status bar indicates the current topic (Wireless shown here) or the name of the setting that is being edited. It also features the settings symbol and battery indicator.



The editing area displays each item that can be set. The highlight bar indicates which setting is currently selected for editing.

Editing area

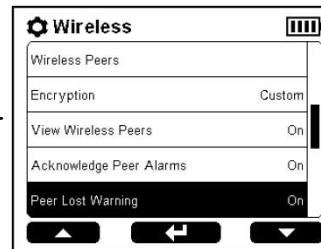

The navigation bar provides control symbols. Each action displayed in the navigation bar is controlled by the button underneath it. The action on the left is controlled by the left button (■), the action shown in the center by the power button (⏻), and the action shown on the right by the right button (■).

Navigation bar

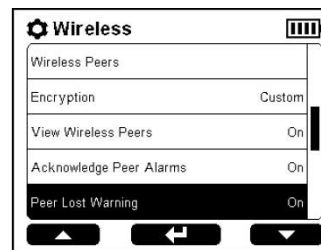

Symbols



Settings.

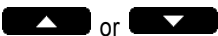

Scroll a list up or down.

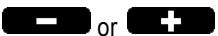

Decrease or increase a highlighted value.



Enter a highlighted value, view additional information for a highlighted option, or confirm a setting change.



Skip an item.

Text

Instructional text may appear in the navigation bar.

Figure 4.1 Display screen overview in settings

Working in Settings

In most cases, a setting is edited without moving to a second display screen as described in the first example shown below using the Peer Lost Warning setting. During editing, the right and left buttons generally perform the same function.

Note: The Radius BZ1 will monitor for gas and its alarms will be functional while editing settings.



Figure 4.2 Example for editing a single-step setting

Changing the setting for the LEL Cal Gas Type is an example of an editing process that first follows the method described above but requires a second step that will generate a new display-screen message. The message will provide additional information and instructions as shown below.

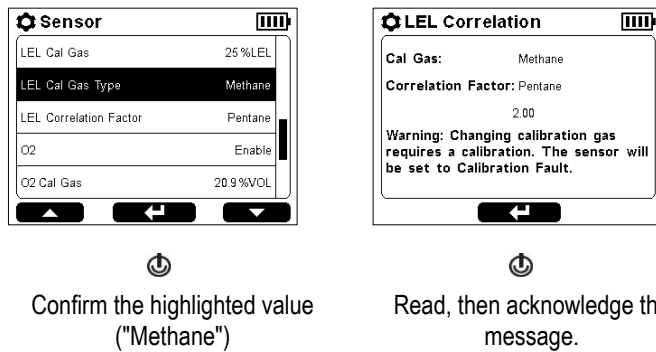

Figure 4.3 Example for editing a multistep setting

Reviewing and Editing Settings

The rest of this chapter describes in detail the options available within each settings topic:

- Maintenance
- Start-up
- Operation
- Alarm
- Sensor
- Admin
- Wireless

From the access instruction and examples provided above, use the instrument buttons to review and adjust the instrument's settings described below in Tables 4.2 through 4.8.

Maintenance Options and Settings

The primary purpose of Maintenance is to provide the safety specialist with the opportunity to view maintenance information and to perform maintenance procedures (utilities).

The safety specialist can also view the instrument's serial number and versioning information, and view and edit the instrument's current user and site assignments.

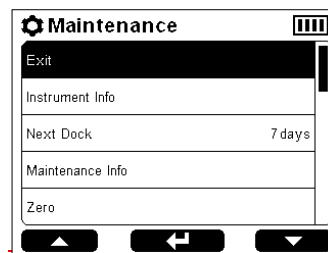

- Move the highlight bar up
- ⏻ Select the highlighted option
- Move the highlight bar down
- ⏻+ Hold Start a utility

Table 4.2 Maintenance options and settings

Option or setting	Description
Instrument Info	View serial numbers, versioning information, available battery power, and installed sensor types. This information is also displayed: company name and the user and site to which the instrument is currently assigned.
Maintenance Info	View the docking or calibration status.
Zero (and calibrate)	Zero the sensors, then optionally calibrate the instrument.
Bump Test	Complete a bump test.
Readings	View and optionally clear the peak, TWA, and STEL readings associated with the installed sensors. <i>Note:</i> When a reading is cleared, its value is reset to zero and its time-related setting is also reset to zero.
User ^a	View and optionally edit the current SafeCore Module user assignment. The five most recently assigned users will be available for selection. The user name will display as the instrument's peer identity.
Site ^a	View and optionally edit the current SafeCore Module site assignment. The five most recently assigned sites will be available for selection.
Self-test	Run the instrument self-test.

^aTo assign a user or site that is not listed, use iNet or DSSAC.

Start-up Settings

These settings allow the safety specialist to permit or prohibit all-user access to start-up options, information that will display during the power-on process.

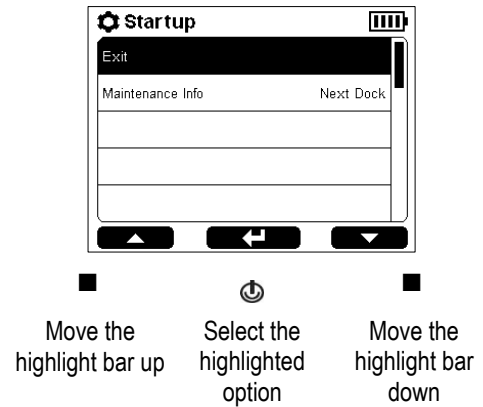

Table 4.3 Start-up settings

Setting	Description and options	
Maintenance Info	Select one format for the maintenance reminder message that can be set to display during the power-on process. Choose one option from among the calibration and dock message options shown below. A dock message selection will override calibration due warnings.	
	<i>Calibration message</i>	<i>Dock message</i>
	Next cal date	Number of days
	Last cal date	
	Days until next	
	Days since last	
German Compliance Check (German-language instruments only)	If the instrument's display language will be set to German, use this setting to prompt the instrument operator, during startup, for a compliance check.	
	<i>Option</i>	<i>Effect</i>
	On	The start-up sequence <i>will</i> require the operator to indicate whether the instrument is or is not in compliance.
	Off	The start-up sequence will <i>not</i> require a compliance check.

Operation Settings

These settings allow the safety specialist to permit or prohibit all-user access—during operation—to information and utilities. Access is set separately for each item. For example, the option to view instrument information may be permitted for all-user access, but the option to zero the instrument may be prohibited.

From operation settings, the always-on feature is also available.

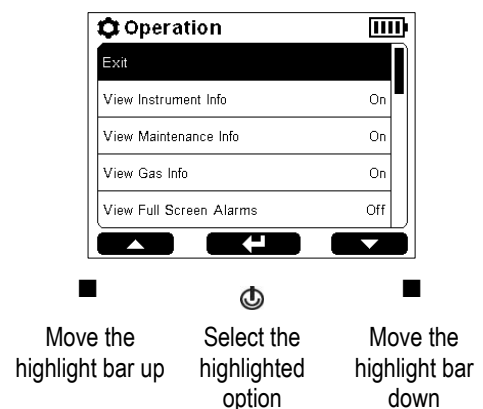

Table 4.4 Operation settings

Setting	Description and options						
	Permit or prohibit all-user access—during operation—to the information items listed here. To permit access, set the option to "On"; to prohibit access, set it to "Off." Set each item separately.						
View Instrument Info	Set all-user access to view serial numbers, versioning information, installed sensor types, company name, and current user and site assignments.						
View Maintenance Info	Set all-user access to view the calibration or docking reminder message.						
View Gas Info	Set all-user access to view alarm setpoints and the calibration gas requirements for each installed sensor.						
View Full-screen Alarms	Set all-user access to view full-screen alarms. When set to "On", the full-screen alarm format will display large-type alarm details for enhanced visual access.						
Perform Zero	Permit or prohibit all-user access—during operation—to perform the utilities listed here. To permit access, set the option to "On"; to prohibit access, set it to "Off." Set each item separately.						
Perform Calibration							
Perform Bump Test							
Clear Peak							
Clear TWA							
Clear STEL							
Always-on Mode	Permit or prohibit all-user access to instrument shutdown.						
	<table border="0"> <thead> <tr> <th><i>Option</i></th> <th><i>Effect</i></th> </tr> </thead> <tbody> <tr> <td>On</td> <td>Prohibits instrument shutdown. The unit will require the user to enter the SafeCore Module's security code before it will shut down. The security code is set in the Admin Settings.</td> </tr> <tr> <td>Off</td> <td>Permits all users to shut down the instrument without the entry of the security code.</td> </tr> </tbody> </table>	<i>Option</i>	<i>Effect</i>	On	Prohibits instrument shutdown. The unit will require the user to enter the SafeCore Module's security code before it will shut down. The security code is set in the Admin Settings .	Off	Permits all users to shut down the instrument without the entry of the security code.
<i>Option</i>	<i>Effect</i>						
On	Prohibits instrument shutdown. The unit will require the user to enter the SafeCore Module's security code before it will shut down. The security code is set in the Admin Settings .						
Off	Permits all users to shut down the instrument without the entry of the security code.						

Alarm Settings

These settings allow the safety specialist to set the values for each gas event that will cause the instrument to alarm.

The specialist can make other choices about instrument behavior including how the instrument communicates alarm events. Options include signal type, audio pattern, and latch feature.

The specialist can also permit or prohibit instrument power off during alarms, and view details about recent alarm events.

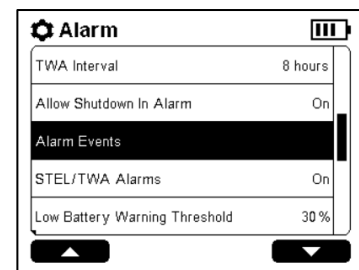

- Move the highlight bar up
- ⏻
Select the highlighted option
- Move the highlight bar down

Table 4.5 Alarm settings

Setting	Description and options										
Alarm	<p>Set the signal type or disable alarm signals. Choose one desired effect from among these options:</p> <table border="0"> <thead> <tr> <th><i>Option</i></th> <th><i>Effect</i></th> </tr> </thead> <tbody> <tr> <td>Visual</td> <td>Lights only</td> </tr> <tr> <td>Audible</td> <td>Speaker only</td> </tr> <tr> <td>Audible and Visual</td> <td>Speaker and lights</td> </tr> <tr> <td>Off</td> <td>No speaker and no lights</td> </tr> </tbody> </table> <p><i>Note:</i> If Off is selected, the instrument will ask for confirmation.</p>	<i>Option</i>	<i>Effect</i>	Visual	Lights only	Audible	Speaker only	Audible and Visual	Speaker and lights	Off	No speaker and no lights
<i>Option</i>	<i>Effect</i>										
Visual	Lights only										
Audible	Speaker only										
Audible and Visual	Speaker and lights										
Off	No speaker and no lights										
Audio Pattern	<p>Set the audio pattern for gas alarms; choose one desired effect from among these options:</p> <table border="0"> <thead> <tr> <th><i>Option</i></th> <th><i>Effect</i></th> </tr> </thead> <tbody> <tr> <td>Dual tone</td> <td>Tone 1 then tone 2</td> </tr> <tr> <td>Single tone</td> <td>Tone 1 only</td> </tr> <tr> <td>Sweep</td> <td>Multiple, escalating tones</td> </tr> <tr> <td>Chirp</td> <td>Multiple, slowly escalating tones</td> </tr> </tbody> </table>	<i>Option</i>	<i>Effect</i>	Dual tone	Tone 1 then tone 2	Single tone	Tone 1 only	Sweep	Multiple, escalating tones	Chirp	Multiple, slowly escalating tones
<i>Option</i>	<i>Effect</i>										
Dual tone	Tone 1 then tone 2										
Single tone	Tone 1 only										
Sweep	Multiple, escalating tones										
Chirp	Multiple, slowly escalating tones										
Alarm Latch	<p>Set the alarm latch feature to "On" or "Off."</p> <table border="0"> <thead> <tr> <th><i>Option</i></th> <th><i>Effect</i></th> </tr> </thead> <tbody> <tr> <td>On</td> <td>Sustain alarm signals after the alarm-causing condition no longer exists and until the alarm is manually turned off. <i>Note:</i> A latched alarm can be turned off by pressing and holding the instrument's left or right button.</td> </tr> <tr> <td>Off</td> <td>Allow alarm signals to turn off after the alarm-causing condition no longer exists.</td> </tr> </tbody> </table>	<i>Option</i>	<i>Effect</i>	On	Sustain alarm signals after the alarm-causing condition no longer exists and until the alarm is manually turned off. <i>Note:</i> A latched alarm can be turned off by pressing and holding the instrument's left or right button.	Off	Allow alarm signals to turn off after the alarm-causing condition no longer exists.				
<i>Option</i>	<i>Effect</i>										
On	Sustain alarm signals after the alarm-causing condition no longer exists and until the alarm is manually turned off. <i>Note:</i> A latched alarm can be turned off by pressing and holding the instrument's left or right button.										
Off	Allow alarm signals to turn off after the alarm-causing condition no longer exists.										
Gas Name (CO, etc.)	<p>For each gas, set the concentration that will cause the instrument to alarm for each possible gas event listed below. The STEL and TWA events apply only to toxic gases.</p> <p>To view alarm setpoints, highlight and select the desired gas name. The setpoint values will display; from the list, highlight and select an event type such as low alarm. Use the left and right buttons, respectively, to decrease or increase the setpoint value, as indicated in the display screen's navigation bar.</p> <p><i>Low Alarm</i></p> <p>Set the value for the gas concentration that will cause a gas-present, low-level alarm.</p> <p><i>High Alarm</i></p> <p>Set the value for the gas concentration that will cause a gas-present, high-level alarm.</p> <p><i>STEL Alarm</i></p> <p>Set the value for the required short-term exposure limit (STEL) for the gas. STEL values reflect the cumulative measure of a gas over a defined period of time. The instrument's STEL time period is set for 15 minutes.</p> <p><i>TWA Alarm</i></p> <p>Set the value for the required time-weighted average (TWA) exposure for the gas. TWA values reflect the average level of exposure to gas over a defined period of time, the TWA interval, which is set by the safety specialist in the next setting listed below.</p>										
TWA Interval	<p>Set the time period (in hours) for the TWA exposure limit. If the TWA setpoint is reached during the set interval, the instrument will activate its TWA alarm.</p>										

Table 4.5 Alarm settings

Setting	Description and options	
Allow Shutdown in Alarm	Use this setting to permit or prohibit instrument shutdown during alarm events.	
	<i>Option</i>	<i>Effect</i>
	On	Allows any user to shut down the instrument while it is in alarm.
	Off	Prohibits shutdown of the instrument when it is in alarm.
Alarm Events	View details for the most recent alarm events. Details include: the alarm-causing sensor and its highest reading during the event; the duration, date, and time of the alarm; and the serial number for the Radius Base that was in use.	
STEL / TWA Alarms	Select one of the options below to control STEL and TWA alarm functionality.	
	<i>Option</i>	<i>Effect</i>
	Off	Both STEL and TWA functionality disabled.
	On	Both STEL and TWA functionality enabled.
	STEL off	TWA functionality enabled; STEL disabled.
	TWA off	STEL functionality enabled; TWA disabled.
Low Battery Warning Threshold	Set the threshold value at which the instrument will alert the user that the battery has diminished to a specified percent of battery charge. This can be set to any value between 5 and 95 (%), inclusive.	

Sensor Settings

These settings allow the safety specialist to enable or disable for operation each installed sensor, and to set the gas concentration required for its calibration.

The LEL correlation and PID response factors can also be edited using these settings.

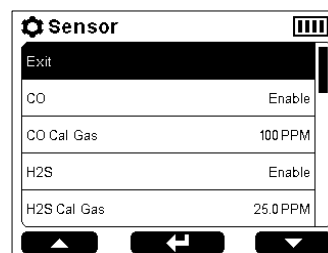

Move the highlight bar up Select the highlighted option Move the highlight bar down

Table 4.6 Sensor settings

Setting	Description and options	
Enable-disable	Each sensor name is displayed with its <i>current</i> operation status.	
	<i>Option</i>	<i>Effect</i>
	Enable	The sensor is operational.
	Disable	The sensor is <i>not</i> operational.
Cal Gas	Each calibration gas type is displayed with its current concentration; the concentration value is editable.	

Table 4.6 Sensor settings

Setting	Description and options														
LEL (or PID) Cal Gas Type	The current calibration gas type is displayed. The calibration gas type can be set for an installed LEL sensor and an installed PID sensor. The available options are: <table border="0"> <tr> <td><i>LEL sensor</i></td> <td><i>PID sensor</i></td> </tr> <tr> <td>Butane</td> <td>Benzene</td> </tr> <tr> <td>Hexane</td> <td>Ethylbenzene</td> </tr> <tr> <td>Hydrogen</td> <td>Isobutylene</td> </tr> <tr> <td>Methane</td> <td>Toluene</td> </tr> <tr> <td>Pentane</td> <td>Mxylene</td> </tr> <tr> <td>Propane</td> <td></td> </tr> </table>	<i>LEL sensor</i>	<i>PID sensor</i>	Butane	Benzene	Hexane	Ethylbenzene	Hydrogen	Isobutylene	Methane	Toluene	Pentane	Mxylene	Propane	
<i>LEL sensor</i>	<i>PID sensor</i>														
Butane	Benzene														
Hexane	Ethylbenzene														
Hydrogen	Isobutylene														
Methane	Toluene														
Pentane	Mxylene														
Propane															
LEL Correlation Factor	The current factor is displayed for each sensor and can be edited. The available options display on screen.														
PID Response Factor															

Admin Settings

Admin settings allow the safety specialist to control important aspects about how the instrument communicates with its operator. For example, a security code can be set to help restrict access to settings.

Note: This will restrict access to settings for *all* users.

The safety specialist can also set the display-screen language, maintenance-related warnings, and other items.

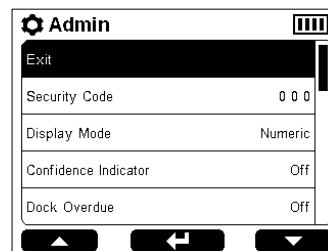

Move the highlight bar up
 Select the highlighted option
 Move the highlight bar down

Table 4.7 Admin settings







Setting	Description and options						
Security Code	Use a valid security code to help protect access to settings and to support always-on operation. <table border="0"> <tr> <td><i>Option</i></td> <td><i>Effect</i></td> </tr> <tr> <td>000</td> <td>Access to settings is unprotected. An instrument set for always-on operation can be powered off.</td> </tr> <tr> <td>Not 000</td> <td>Access to settings is protected by a security code. An instrument set for always-on operation can be powered off <i>only</i> after entering the security code.</td> </tr> </table>	<i>Option</i>	<i>Effect</i>	000	Access to settings is unprotected. An instrument set for always-on operation can be powered off.	Not 000	Access to settings is protected by a security code. An instrument set for always-on operation can be powered off <i>only</i> after entering the security code.
<i>Option</i>	<i>Effect</i>						
000	Access to settings is unprotected. An instrument set for always-on operation can be powered off.						
Not 000	Access to settings is protected by a security code. An instrument set for always-on operation can be powered off <i>only</i> after entering the security code.						
Display Mode	Choose the manner in which gas readings are displayed, numeric or text format. <table border="0"> <tr> <td><i>Option</i></td> <td><i>Effect</i></td> </tr> <tr> <td>Numeric format</td> <td> The instrument operator will see detailed readings.</td> </tr> <tr> <td>Text format</td> <td> The instrument operator will see a status message.</td> </tr> </table>	<i>Option</i>	<i>Effect</i>	Numeric format	 The instrument operator will see detailed readings.	Text format	 The instrument operator will see a status message.
<i>Option</i>	<i>Effect</i>						
Numeric format	 The instrument operator will see detailed readings.						
Text format	 The instrument operator will see a status message.						

Table 4.7 Admin settings

Setting	Description and options										
Confidence Indicator	When the confidence indicator is <i>not</i> set to Off, the instrument emits a visual or audible signal to indicate that it is powered on.										
	<table border="0"> <thead> <tr> <th><i>Option</i></th> <th><i>Effect</i></th> </tr> </thead> <tbody> <tr> <td>Off</td> <td>No signals</td> </tr> <tr> <td>Audible</td> <td>Chirp</td> </tr> <tr> <td>Visual</td> <td>Blue lights</td> </tr> <tr> <td>Audible and Visual</td> <td>Chirp and blue lights</td> </tr> </tbody> </table>	<i>Option</i>	<i>Effect</i>	Off	No signals	Audible	Chirp	Visual	Blue lights	Audible and Visual	Chirp and blue lights
<i>Option</i>	<i>Effect</i>										
Off	No signals										
Audible	Chirp										
Visual	Blue lights										
Audible and Visual	Chirp and blue lights										
Confidence-indicator Interval	Set the interval for the instrument's confidence-indicator signals. The value can be set in 5-second increments from 15 to 90 seconds.										
Dock Due Calibration Due Bump Due	Select how the instrument will alert its operator of maintenance-due warnings. For each warning, choose the desired effect from the options listed below. <i>Note:</i> If the dock-due option is selected, its warning will override the calibration-due and bump-due warnings.										
	<table border="0"> <thead> <tr> <th><i>Option</i></th> <th><i>Effect</i></th> </tr> </thead> <tbody> <tr> <td>Off</td> <td>No signals</td> </tr> <tr> <td>Audible</td> <td>Chirp</td> </tr> <tr> <td>Visual</td> <td>Blue lights</td> </tr> <tr> <td>Audible and Visual</td> <td>Chirp and blue lights</td> </tr> </tbody> </table>	<i>Option</i>	<i>Effect</i>	Off	No signals	Audible	Chirp	Visual	Blue lights	Audible and Visual	Chirp and blue lights
<i>Option</i>	<i>Effect</i>										
Off	No signals										
Audible	Chirp										
Visual	Blue lights										
Audible and Visual	Chirp and blue lights										
Sync Interval Calibration Interval Bump Interval	Select the interval for each maintenance due warning. The "sync" interval controls the dock-due warning.										
	<table border="0"> <thead> <tr> <th><i>Interval type</i></th> <th><i>Value</i></th> </tr> </thead> <tbody> <tr> <td>Sync</td> <td>One-day increment</td> </tr> <tr> <td>Calibration</td> <td>One-day increment</td> </tr> <tr> <td>Bump</td> <td>Half-day increment</td> </tr> </tbody> </table>	<i>Interval type</i>	<i>Value</i>	Sync	One-day increment	Calibration	One-day increment	Bump	Half-day increment		
<i>Interval type</i>	<i>Value</i>										
Sync	One-day increment										
Calibration	One-day increment										
Bump	Half-day increment										
Bump Pass Limit Bump Max Time	Sensors pass a bump test when they sense the specified percentage of calibration gas (or "pass limit") within the specified response-time setting (or "max time"). Set each to a value within its available range. Pass limit: 50–99% Response-time: 30–120 seconds										
Language	Set the instrument's display language. Choose from the on-screen options.										
Data and time settings	The instrument uses date and time settings to date- and time-stamp its data-log entries (including alarms). The time setting also appears on the display screen during operation. Date format: DD-Month-YYYY Time format: 12-hour or 24-hour clock. Time: enter values based on the selected time format.										
Backlight Mode	Set the instrument's backlight behavior. Choose the desired effect from among these options, which are listed in order from lowest power consumption to highest power consumption:										
	<table border="0"> <thead> <tr> <th><i>Option</i></th> <th><i>Effect</i></th> </tr> </thead> <tbody> <tr> <td>Off</td> <td>Always off.</td> </tr> <tr> <td>Automatic</td> <td>Turns on when a button is pressed and the instrument senses low-light conditions.</td> </tr> </tbody> </table>	<i>Option</i>	<i>Effect</i>	Off	Always off.	Automatic	Turns on when a button is pressed and the instrument senses low-light conditions.				
<i>Option</i>	<i>Effect</i>										
Off	Always off.										
Automatic	Turns on when a button is pressed and the instrument senses low-light conditions.										

Table 4.7 Admin settings

Setting	Description and options	
	Continuous	Always on.
Backlight Interval	When the backlight mode is set to <i>automatic</i> , the interval setting determines how long the light remains on (between 5 and 60 seconds).	
Data-log Interval	Set the interval (in seconds) when the instrument's readings will be saved to the data log.	
	<i>Interval value</i>	<i>Effect</i>
	1 s	The actual reading is saved to the data log.
	>1 s	The average of readings taken over the interval is saved to the data log; data-log capacity is conserved.
Data-log Status	When the data log reaches its capacity, it will begin to overwrite data. The Data-log Status display helps the safety specialist determine if the data log is nearing capacity by supplying the current values for these items: Data-log interval setting Current session number Remaining time estimate Usage: percentage of capacity used	

Wireless Settings

Wireless settings allow the safety specialist to control LENS Wireless functionality. This includes whether instrument data can be transmitted to iNet for live-monitoring access by users of iNet Now, and how the instrument will behave with respect to its peers, the gas-detection instruments within the LENS group. GPS options are also set within this menu.

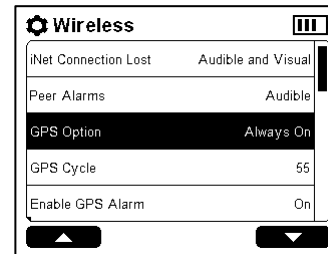

Move the highlight bar up
 Select the highlighted option
 Move the highlight bar down

Table 4.8 Wireless settings

Setting	Description and options	
LENS Wireless	Use this setting to control whether the instrument can join LENS Wireless groups and send data to iNet for the live monitoring of the unit.	
	<i>Option</i>	<i>Effect</i>
	iNet Now and Local	LENS Wireless is operational. This instrument is available to join LENS groups. It will also transmit data to iNet for live monitoring by users of iNet Now.
	Local	LENS Wireless is operational. This instrument is available to join LENS group but <i>will not</i> transmit data to iNet for live monitoring by users of iNet Now.
	Off	LENS Wireless is <i>not</i> operational. The instrument is <i>not</i> available to join LENS groups and <i>cannot</i> send data to iNet for live monitoring by users of iNet Now.

Table 4.8 Wireless settings

Setting	Description and options	
LENS Power Mode	Use this setting to control whether the instrument's radio-power transmission level is in compliance with CE RED ^a .	
	<i>Option</i>	<i>Effect</i>
	CE RED	Compliant with CE RED.
	World	Not compliant with CE RED.
	<i>Note:</i> If this setting is changed (from CE RED to World or World to CE RED) the instrument will go into an iNet Connection Lost alarm for approximately one minute while the LENS radio reboots. After rebooting, it will reconnect at the new setting and the alarm will clear.	
Group	Use this setting to control how the instrument can join a LENS group.	
	<i>Option</i>	<i>Effect</i>
	Scan	Allows the instrument to scan for and join a LENS group. The instrument scans for in-range groups, selecting a group based on network strength and number of LENS peers in the group. The instrument will continue to scan until it detects and automatically joins an available LENS group with a vacancy (less than 25 peers).
	Named Group	Assigns the instrument to a named LENS group (<i>Values:</i> "A" through "J"). <i>Note:</i> An instrument <i>cannot</i> join any other LENS group without changing the setting to <i>Scan</i> or a different named group, e.g., "B".
	<i>Note:</i> The "Scan" option permits the instrument to join an unnamed, ad hoc formed group or a named group (e.g., Group X). When both "Scan" and "iNet Now and Local" settings are selected, the Radius will scan until it finds and joins a group that includes an iNet-connected gateway.	
Wireless Peers	View the list of peer instruments that are assigned to the instrument's group and access the gas readings for any listed peer instrument.	
	<p>To add a Ventis Pro instrument to the LENS group, choose the "Join new peer" option.</p> <p>Then, point the Ventis Pro IrDA window at the Radius IrDA window. Hold the Ventis Pro very close to the Radius for approximately five seconds or until the Ventis Pro emits an ascending tone to indicate success.</p>	
Encryption	Select the encryption key that is used to secure the instrument's transmitted, wireless data.	
	<i>Option</i>	<i>Effect</i>
	Default	Use the Industrial Scientific encryption key.
	Custom	Use an encryption key other than the Industrial Scientific default option. This option requires the use of iNet or DSSAC.
View Wireless Peers	Set whether all users can view gas readings—during operation—for peer instruments that are within the instrument's assigned LENS group.	
	<i>Option</i>	<i>Effect</i>
	On	Peer instrument gas readings will be accessible on-demand during operation.
	Off	Peer instrument gas readings will <i>not</i> be on-demand accessible during operation.

Table 4.8 Wireless settings

Setting	Description and options	
Peer Alarms	Set whether the instrument will emit alarm signals for peer-instrument events.	
	<i>Option</i>	<i>Effect</i>
	On	The instrument <i>will</i> emit signals when a LENS peer instrument is in alarm; choose a signal type of audible, visual, or both audible and visual.
	Off	The instrument will <i>not</i> emit signals when a LENS peer instrument is in alarm. The display screen will indicate that the peer alarms are off.
Acknowledge Peer Alarms	Set whether to turn off the LED and audible signals for all users when the instrument is in peer alarm ^b .	
	<i>Option</i>	<i>Effect</i>
	On	Permits users to turn off the visual and audible alarm signals when the instrument is in peer alarm.
	Off	Prohibits users from turning off the visual and audible alarm signals when the instrument is in peer alarm.
Peer Lost Warning	Set whether the instrument will alarm when another instrument in the group becomes "lost." A peer instrument is considered lost when it is no longer communicating within the group for an unexpected reason. For example, if a peer instrument is moved, it may be outside the range for connection with any instrument in the group. <i>Note:</i> These intentional actions will <i>not</i> cause a Peer Lost Warning: the instrument is powered off, its group assignment is changed, or its radio is turned off.	
	<i>Option</i>	<i>Effect</i>
	On	The instrument will emit an alarm when a peer instrument is lost.
	Off	The instrument will <i>not</i> emit an alarm when a peer instrument is lost.
Acknowledge Peer Lost	When the Peer Lost Warning (above) is set to "On", use the Acknowledge Peer Lost feature to allow the instrument operator to turn off the LED and audible signals ^b when a peer is lost.	
	<i>Option</i>	<i>Effect</i>
	On	<i>Permits</i> users to turn off the visual and audible alarm signals when the instrument is in peer lost warning.
	Off	<i>Prohibits</i> users from turning off the visual and audible alarm signals when the instrument is in peer lost warning.
Group Lost Warning	Use this setting to control whether the instrument will warn its operator that there are no peer instruments remaining in the group.	
	<i>Option</i>	<i>Effect</i>
	On	The instrument will emit a warning when it becomes separated from its group.
	Off	The instrument will <i>not</i> emit a warning when it becomes separated from its group.

Table 4.8 Wireless settings

Setting	Description and options	
Acknowledge Group Lost	When the Group Lost Warning (above) is set to "On", use the Acknowledge Group Lost feature to allow the instrument operator to turn off the LED and audible signals ^b when the instrument becomes separated from its LENS wireless peer group.	
	<i>Option</i>	<i>Effect</i>
	On	The instrument will emit a warning when it becomes separated from its group.
	Off	The instrument will <i>not</i> emit a warning when it becomes separated from its group.
iNet Connection-lost warning	The instrument will emit warning signals when it has lost its wireless connection to iNet. Choose the desired effect from these options.	
	<i>Option</i>	<i>Effect</i>
	Visual	The instrument will emit <i>only</i> a visual signal to indicate the connection is lost.
	Visual and audible	The instrument will emit <i>both</i> visual and audible signals to indicate the connection is lost.
GPS Option	Use this setting to allow the unit to obtain its GPS coordinates.	
	<i>Option</i>	<i>Effect</i>
	Always On	The instrument will attempt to obtain GPS coordinates, at a set interval, for upload to iNet. The GPS module remains fully powered between GPS cycles, which provides more reliable positioning but will decrease battery ^c runtime.
	Battery Saver	The instrument will attempt to obtain GPS coordinates, at a set interval, for upload to iNet. The GPS module enters a low power state between GPS cycles to preserve battery ^c runtime.
	Off	The instrument <i>cannot</i> obtain its GPS coordinates.
GPS Cycle	Set the interval (in minutes) at which the instrument will obtain its GPS coordinates.	
	Value	1 to 60 minutes
Enable GPS Alarm	Enable or disable the No GPS Signal Warning.	
	<i>Option</i>	<i>Effect</i>
	On	An alarm will sound and display when the instrument loses the GPS signal if the GPS Option is set to <i>Always On</i> or <i>Battery Saver</i> .
	Off	No alarm will sound or display when the instrument loses the GPS signal if the GPS Option is set to <i>Always On</i> or <i>Battery Saver</i> .

^aTo determine if CE RED compliance is required, see your safety team manager. This setting affects the unit's wireless connection range; for more information, see [Table 1.4 Range guidelines for LENS Wireless connections by LENS power mode setting](#).

^bThe display-screen messaging is not affected; in the designated area, it will contain details about the peer alarm or warning.

^cOnly affects instruments powered by the Radius Base battery pack or the SafeCore Module battery.

Power

Charging the Battery

Power On

Shutdown

Maintaining Battery Charge

Charging the Battery

Before first use and as needed—in an area known to be nonhazardous—charge the Radius Base battery as described below in Figure 5.1. Charging can be done whether or not a SafeCore® Module is installed. Regardless, the instrument will *not* be functional while it is charging.

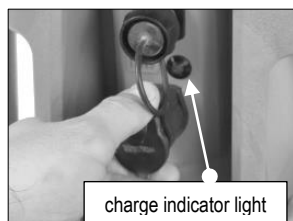

Pull on the charging port's tethered cap to remove it. Note the location of the charge indicator light.







Insert the power supply cord into the charging port, metal tab facing up. When fully inserted, the tab clicks into place.



Connect the power supply to its cord; then, connect the power cord to a suitable outlet.

The battery's charge state (conditioning, charging, or ready) is indicated by the symbol on the display screen (if the module is installed) and the green charge-indicator light located on the back of the Radius Base.

Charge state	Light	Display symbol
Conditioning	Blinking	 
Charging	On	 
Ready	Off	

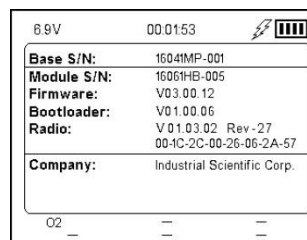



When charging is complete, press the power cord connector tab and pull to disconnect the power cord from the instrument.



Install the port cap before using the instrument in a hazardous classification area for which it is certified.

Figure 5.1 Battery charging instructions

Power on

To power on the Radius® BZ1 Area Monitor, press and hold the power button (⏻) for approximately three seconds. Tones emitted from the speaker during the power-on process are lower in volume compared to the audible alarm signals. The alarm muffler accessory from Industrial Scientific may be used to further diminish the volume; be sure to remove the muffler before instrument operation.

The instrument will perform a *self-test*; its operator should observe the instrument and its display to verify the unit is functioning as expected. Immediately following the self-test is the *start-up sequence*, which will provide information and may prompt the instrument operator to prepare the instrument for use.

The full power-on process is shown below in Figure 5.2, which includes button-press instructions where needed. The process may vary from that shown below depending on instrument settings and whether a pump is installed. At the end of the power-on process, the "home" screen will display.

Self-test

Light test



The blue lights will flash followed by the red lights. Verify that all lights are functional.

Display test

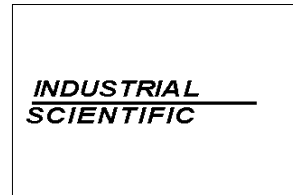

Observe the display screen to verify that all pixels are functional.

Speaker test



The unit emits a beep. Verify that the speakers are functional.

Sample error message

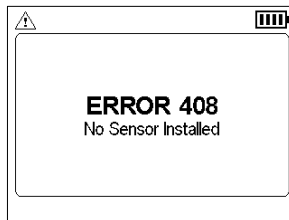

If the unit fails any part of its self-test, an error message will display. If the unit or its operator detect problems, contact Industrial Scientific.

Start-up sequence

Set date and time

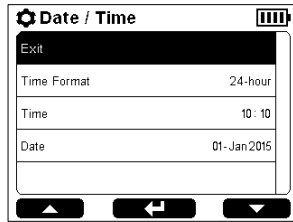

- - 
 -
- Move the highlight bar up Choose the high-lighted item Move the highlight bar down
-
- Edit the highlighted value Enter the high-lighted value Edit the highlighted value

Instrument information

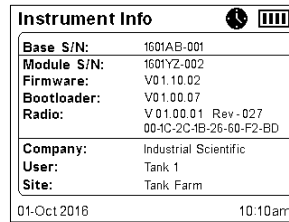

Provides identifying information about the instrument and its installed sensors, available battery power, and assignments (company, user, and site).

Radio firmware update

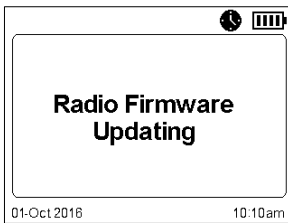

The SafeCore Module is installing improvements.

Company message



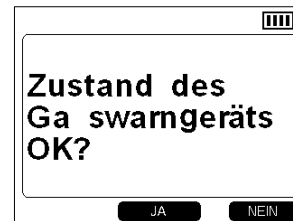

Acknowledge message

Compliance check^a

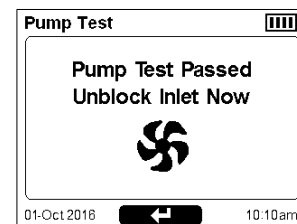
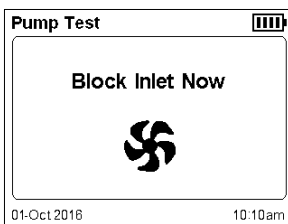

 ■
JA (Yes) NEIN (No)

Pump test (aspirated units only)



Block the end of the sampling line with your thumb to restrict air flow.
When the pump test is complete, the system will prompt you to unblock the inlet.

Press the power () button to continue.

Note: A failed pump test may indicate a problem in the sampling line. Check and correct for cracks or other damage, debris, and improper installation in these areas: tubing, all sampling line connections, and the pump inlet water barrier.

Maintenance information



The dock information (above) indicates maintenance is due in the future (“days until”).

Maintenance Info

S#	Sen	Last Cal	Span
1	CO	31-May 2016	156 %
2	H2S	31-May 2016	175 %
3	LEL	31-May 2016	304 %
4	—	—	—
5	O2	31-May 2016	136 %
6	—	—	—

01-Oct-2016 10:10am

The calibration information (above) indicates the date on which the maintenance was last performed and the span reserve percentage (span) for each sensor. Calibration data can also be set to display as due in the future. When the span is less than 50%, a sensor will no longer pass calibration.

Gas information

Gas Info

S#	Sen	⚡↓	⚡↑	Unit
1	CO	35	70	PPM
2	H2S	10.0	20.0	PPM
3	LEL	10	20	%LEL
4	—	—	—	—
5	O2	19.5	23.5	%VOL
6	—	—	—	—

01-Oct-2016 10:10am

These setpoints are provided for each gas: gas-present low alarm and high alarm, TWA alarm, STEL alarm, and calibration gas.

Verify that the settings are appropriate.

Gas Info

S#	Sen	TWA	STEL	🔧	Unit
1	CO	35	200	100	PPM
2	H2S	10.0	15.0	25.0	PPM
3	LEL	—	—	25	%LEL
4	—	—	—	—	—
5	O2	—	—	20.9	%VOL
6	—	—	—	—	—

01-Oct-2016 10:10am

End of power-on process

Home screen (4 gas instrument)

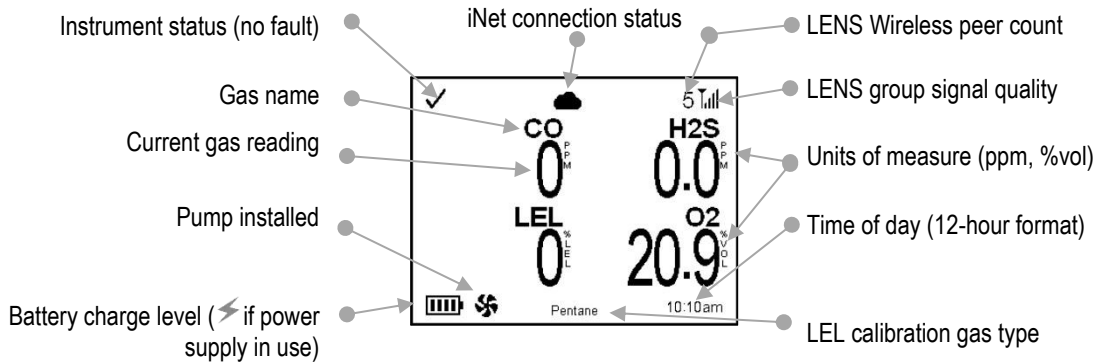

Figure 5.2 Power-on process

^aGerman-language instruments only.

Shutdown

To start the shut-down process, which powers off the instrument, press and hold the power button (⏻).

Shutdown confirmation



When prompted, confirm shutdown: press ⏻. Without confirmation, the instrument will remain on.

Shutdown in progress

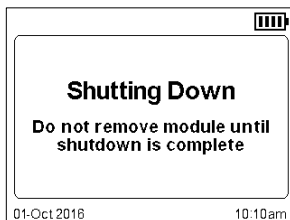

Allow the instrument to complete shutdown before removing the SafeCore Module.

Figure 5.3 Shut-down process

Quick-status Information

When the unit is powered off, the installed sensor types, available battery power, and other information can be viewed without powering on the unit: simultaneously press and hold the left and right buttons. The quick-status screen also displays during charging.

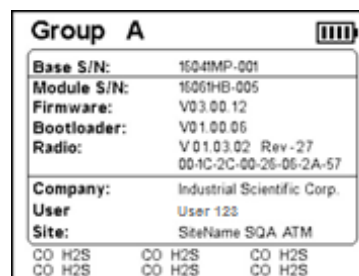

Maintaining Battery Charge

During operation of the Radius BZ1, use a compatible power-supply accessory from Industrial Scientific to extend instrument run time. Each accessory has its own hazardous-classified area restrictions, run-time effects, and should only be used in accordance with its *product manual*.

Table 5.1 Power supply run-time effects

Power supply (product manual part number)	Radius BZ1 run-time
Solar Power Supply (17159773)	Indefinite
Intrinsically Safe Extended Run Time Power Supply (17158248)	Indefinite ^a and ^c
Extended Run Time Power Supply (17158385)	30 days or more ^b and ^c

^aRun time may reach up to 7 days, but is not indefinite, for an *aspirated* unit that is operating at room temperature 25 °C [77 °F]) with more than one LEL sensor and CO, H₂S, and O₂ sensors installed, has the wireless option enabled, and experiences 10 minutes of high alarm per day.

^bApproximate run time when used with the Radius BZ1 Area Monitor that has a fully charged battery powering a *diffusion* unit that is operating at room temperature (25 °C [77 °F]) with CO, H₂S, O₂, and LEL sensors installed, has the wireless option enabled, and experiences 10 minutes of high alarm per day.

^cMaximum run time for a diffusion unit, with a PID sensor, is approximately four and seven days for the ERTPS and ISERTPS, respectively.

Operation

Placing the Instrument

In-field Precautions

LENS Wireless

Live Monitoring

Gas Readings

Operating the Instrument

Alarms, Warnings, and Indicators

Resolving Failures and Errors

Placing the Instrument

A placement plan (see Chapter 1, “[Recommended Practices](#)”), which is based on gas properties, site needs, and wireless factors, will determine the best location for each Radius® BZ1 Area Monitor. At the desired location:

- Place the instrument on a level, stable surface.
- Place the instrument where it cannot fall.
- To achieve best performance for a unit that will use GPS, ensure that the site provides ample, open-sky access. Units used in an indoor environment *cannot* receive the signal required for GPS functionality.

In-field Precautions

Before operating the instrument, take these in-field precautions:

- Verify that the calibration cup is not in the gas path and that the gas path is clear of snow, mud, ice, and other obstructions.
- Verify that the alarm muffler is *not* covering the speaker.
- Verify the instrument's alarms are *not* turned off. Contact a supervisor if this message appears in the display's navigation bar: "⚠ Alarms Off."
- If a compatible power supply from Industrial Scientific is in use, verify that the instrument is receiving power by checking the instrument display screen for the power-supply symbol (⚡).

LENS Wireless

A LENS™ group can include Radius BZ1 Area Monitors, Ventis® Pro instruments, and compatible gateway units. If part of a LENS group, the following apply to Radius BZ1 instruments.

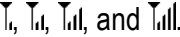
- To maintain a LENS wireless connection, use the line-of-sight distance guidelines provided in Chapter 1 (see [Table 1.4](#)).
- Check the instrument's "Wireless Peers" setting to verify that the instrument is included in the peer list.
- Check the home screen to assess signal quality. From lowest to highest signal quality, the symbols are: .
- If the instrument's LENS Wireless Group is set to the *scan* option, it can scan for and join in-range LENS groups with a vacancy; if set to a named LENS group (e.g. "B"), the instrument remains in that group until the setting is changed to another group (e.g. "C"); or to *scan*.
- If an instrument becomes separated from its group, its display screen may feature a "Group Lost" message; its peer instruments may display a "Peer Lost" message. When separated from its group, the instrument will continually attempt to rejoin the LENS group.
- If an instrument loses its connection to iNet®, it will warn of the condition by continually emitting a visual-only or visual-and-audible signal.

Note: While highly resistant to interference from other wireless devices, avoid using devices of high electromagnetic interference (EMI) near the instrument.

Live Monitoring



iNet Now, a service of Industrial Scientific, is part of a wireless system that provides for the live monitoring of gas-detection instruments. Instrument data is uploaded, via a compatible gateway, to iNet. From iNet, the safety team, using *iNet Now*, can monitor gas hazards on a live basis.

Live monitoring requires the following.

- Activation of the *iNet Now* service.
- Activation of the instrument (through iNet) for live monitoring.
- A wireless connection between the instrument and a compatible gateway.

Note: Instrument settings and connection guidelines also apply as described in this manual.

During instrument operation, the cloud symbol that appears on the Radius BZ1's display screen indicates the following about live-monitoring status.

- A solid cloud () indicates instrument data are reaching iNet and are available to users of *iNet Now* for the live monitoring of instrument status.
- A cloud with a line through it () indicates instrument data are *not* reaching iNet and *iNet Now* users *cannot* monitor instrument status. See a supervisor for assistance.

Each of the compatible gateways has some unique aspects to its functionality as described below.

RGX Gateway and TGX Gateway

For instrument data to reach a compatible gateway, the Radius BZ1 and the gateway must be members of the same LENS group.

Counting gas-detection instruments and gateway units, a LENS group can include up to 25 equipment items. For example, if one RGX and one TGX are used to monitor Group A, the group can accommodate 23 gas-detection instruments.

Note: The maximum size for a LENS group varies for these specialized applications: 1.) six when a smart-device gateway is in use and 2.) eight when a peer RGX Gateway is used and set to Dynamic Monitoring for plume modeling.

Smart-device gateway

Data from a Radius BZ1 can reach iNet through a smart-device gateway when the following are true.

- The smart device is running the iNet Now Sync App.
- At least one member of the LENS group is a Ventis Pro that is within range (approximately 30 m [32.8 yards]) of the smart device. This provides the required gateway connection for the transmission of Radius data to iNet.
- The LENS group can include up to six gas-detection instruments.

Gas Readings

After a unit has been powered on, its self-test and start-up sequence successfully completed, gas readings will display. As noted earlier in this manual, this display is referred to as the “Home” screen. The display will vary based on the number of installed, operational sensors. As shown below, the home screen may display actual gas readings (numeric view) or a general statement about the readings (text view).

During operation, the home screen will display unless the instrument is using the display to provide information about an alarm, warning, indicator, or status item.

Home screen

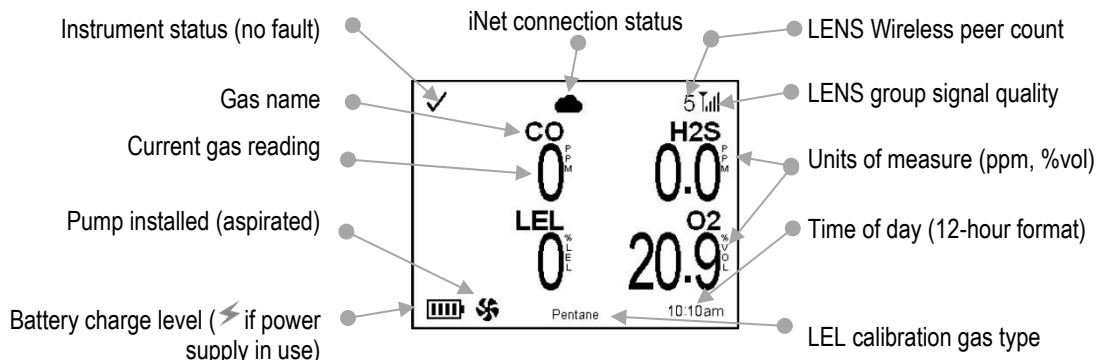

Numeric view

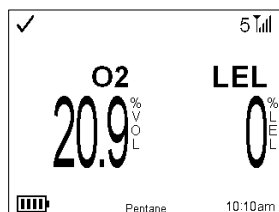

Home screen - two installed sensors

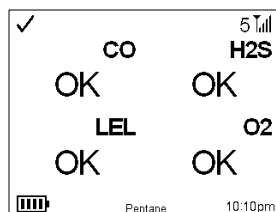

Text view

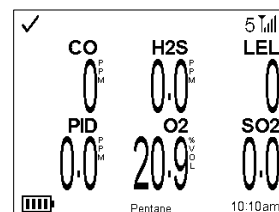

Home screen - six installed sensors

Figure 6.1 Home screen variations

Operating the Instrument

From the home screen, a series of display screens may be accessible during operation. Some are purely informational while others provide access to maintenance utilities such as bump testing and calibration; options vary based on instrument settings.

Information

Information screens display briefly and may include:

- The instrument's serial numbers, versioning information, and the company, user, and site assigned to the instrument.
- The number of days until the SafeCore® Module is due to be docked for maintenance.
- The date each installed sensor is next due for calibration (or was last calibrated) and its span reserve percentage value.

Note: The span reserve percentage is an indicator of a sensor's remaining life. When the value is less than 50%, the sensor will no longer pass calibration.

- The alarm setpoints and the calibration gas requirements for each installed sensor.
- The instrument's wireless peer list and optional access to peer instrument readings.

Utilities

Utilities give instrument users opportunities to complete maintenance procedures, which may include:

- Zero the installed sensors and calibrate the SafeCore Module.
- Bump test the installed sensors.
- View and optionally clear the peak, TWA, and STEL readings.

Note: When a reading is cleared, its value is reset to zero and its time-related setting is also reset to zero.

Figure 6.2 describes how to access options during operation. The navigation bar across the bottom of the display will sometimes provide instructions. When that is the case, each displayed action is controlled by pressing the button located underneath it. The instrument will wait approximately 30 seconds between button presses; when no button is pressed, it will revert to the home screen or the prior display screen.

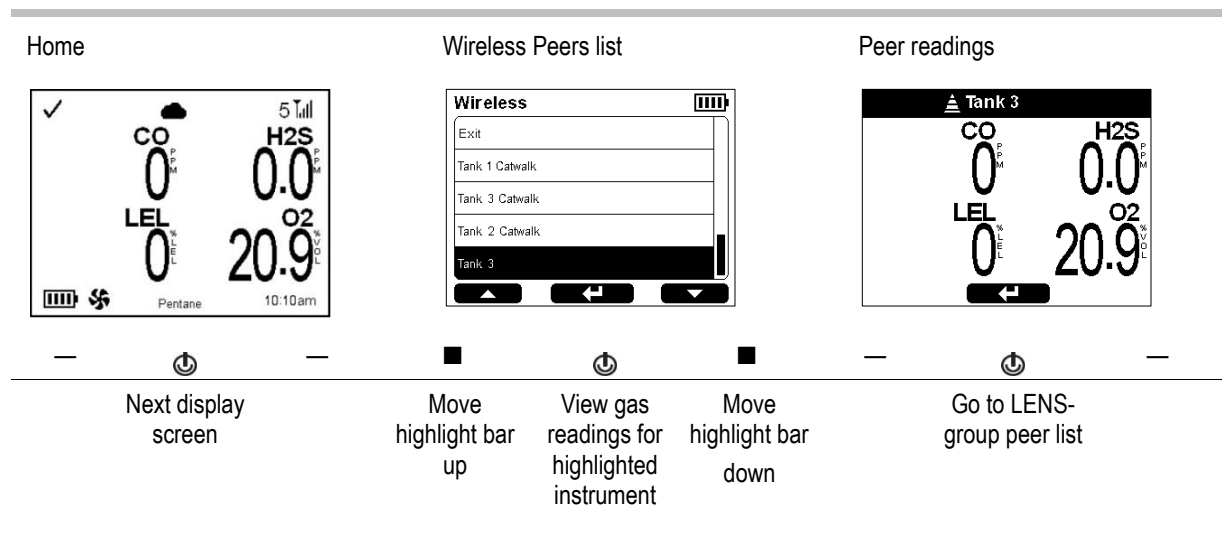

Instrument information

Instrument Info	
Base S/N:	1601AB-001
Module S/N:	1601YZ-002
Firmware:	V01.10.02
Bootloader:	V01.00.07
Radio:	V01.00.01 Rev - 027 00-1C-2C-1B-26-60-F2-BD
Company:	Industrial Scientific
User:	Tank 1
Site:	Tank Farm

Next display screen

Maintenance information (Calibration and span format)

Maintenance Info			
S#	Sen	Last Cal	Span
1	CO	31-May 2016	156%
2	H2S	31-May 2016	175%
3	LEL	31-May 2016	304%
4	—	—	—
5	O2	31-May 2016	136%
6	—	—	—

Next display screen

(Docking format)

Maintenance Info	
Next Dock	
7	
days until	

Next display screen

Gas information

Gas Info				
S#	Sen	↔	↔	Unit
1	CO	35	70	PPM
2	H2S	10.0	20.0	PPM
3	LEL	10	20	%LEL
4	—	—	—	—
5	O2	19.5	23.5	%VOL
6	—	—	—	—

Next display screen

Gas information (continued)

Gas Info				
S#	Sen	TWA	STEL	Unit
1	CO	35	200	100 PPM
2	H2S	10.0	15.0	25.0 PPM
3	LEL	—	—	25 %LEL
4	—	—	—	—
5	O2	—	—	20.9 %VOL
6	—	—	—	—

Next display screen

Zero utility

Zero	
0	

Next display screen

+ Hold
Start the utility

Bump test utility

Bump Test	
B	

Next display screen
+ Hold
Start the utility

Summary readings

Readings					
S#	Sen	↔	TWA	STEL	Unit
1	CO	100	0	0	PPM
2	H2S	28.0	0.0	0.0	PPM
3	LEL	100	—	—	%LEL
4	—	—	—	—	—
5	O2	9.1	—	—	%VOL
6	—	—	—	—	—

Next display screen
+ Hold
Start the utility

Figure 6.2 Operation instruction

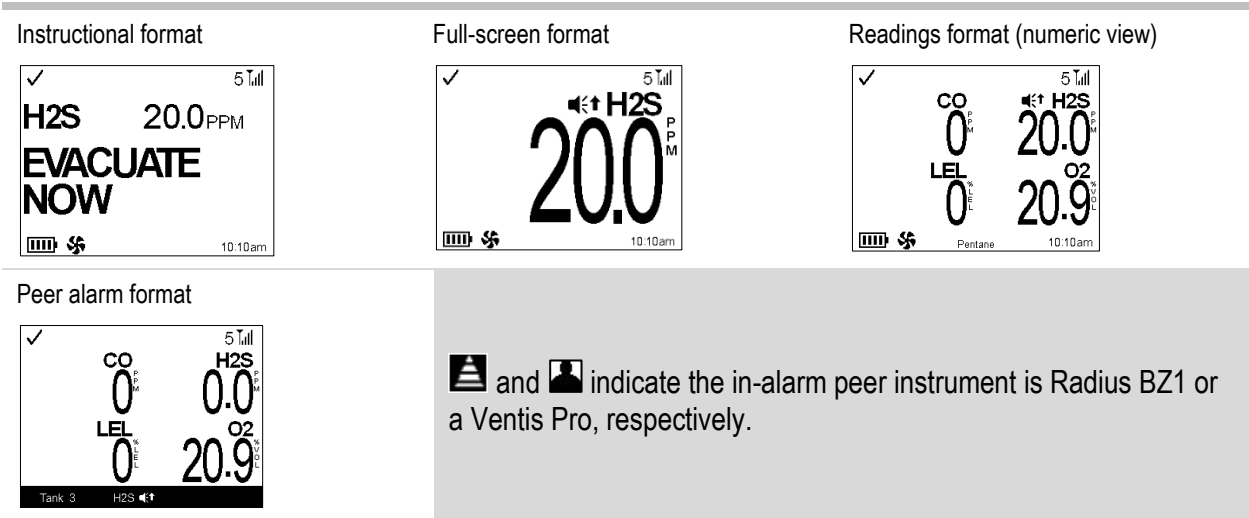

Figure 6.4 Example alarm and peer-alarm display-screens

The display screens shown above feature the symbols for a high alarm (⏪↑) and peer high alarm (⏪↑). When an alarm is caused by another type of event, the display screens will feature a different symbol as shown in Figure 6.5, which also indicates relative signal intensity.

Alarm level	Signal intensity
Event types	Event symbol
High Alarm	
Gas present (positive over-range event)	OR
Gas present (high-alarm event)	
STEL event	STEL
System error (408 shown)	ERROR 408
Critical low battery	Low Battery Shutdown
Low Alarm	
Gas present (low-alarm event)	
TWA event	TWA
Negative over-range	-OR

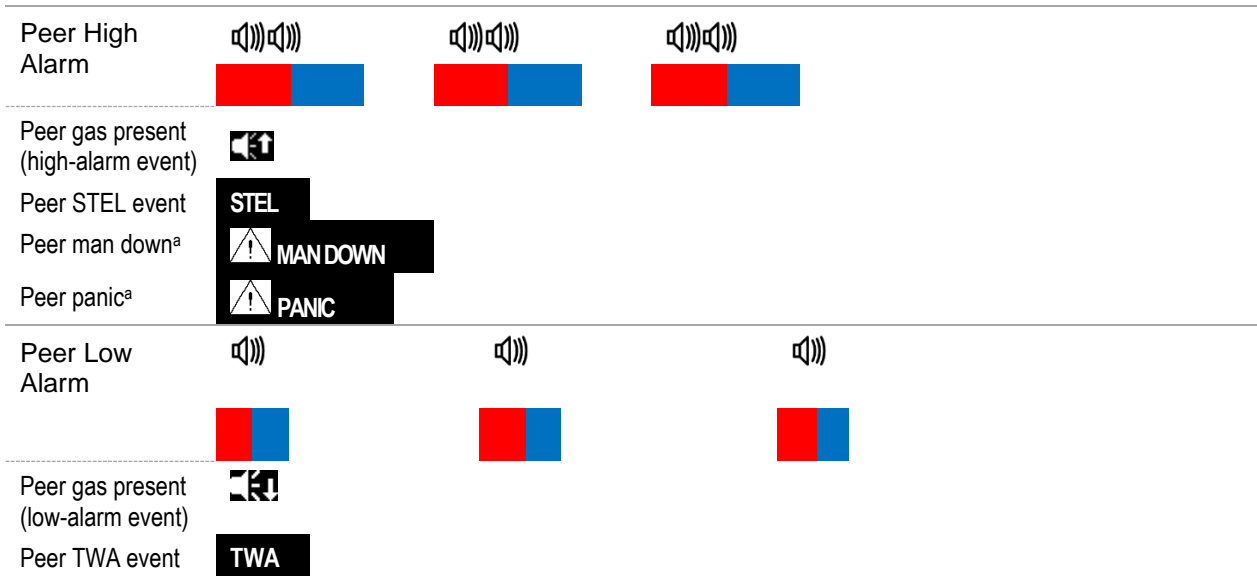

Figure 6.5 Alarms, possible causes, and relative signal intensity

^aWhen displayed in the peer alarm format, the in-alarm instrument is a Ventis Pro.

The example below describes and illustrates the sharing of alarm information for instruments that are operating as peers in a LENS group.

Example: Peer instruments with one in high alarm

Instrument "Tank 3" and "Tank 2" are peer instruments in a LENS peer group.

The Tank 3 instrument has detected 20.0 ppm H₂S, which has caused a high alarm. This means its operator is in immediate danger, so the instrument will emit alarm signals of the highest intensity as shown.

The Tank 2 instrument will emit alarm signals of lower intensity to indicate a peer instrument is in alarm. Display screen details indicate that colleagues at the Tank 3 are in immediate danger and provide the alarm-event symbol.

Instrument in high alarm

Tank 3

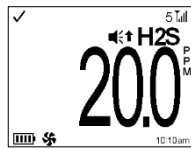

Event: Gas present, high alarm
20.0 ppm H₂S

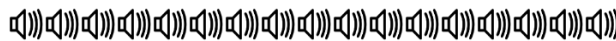

Instrument in peer high alarm

Tank 2

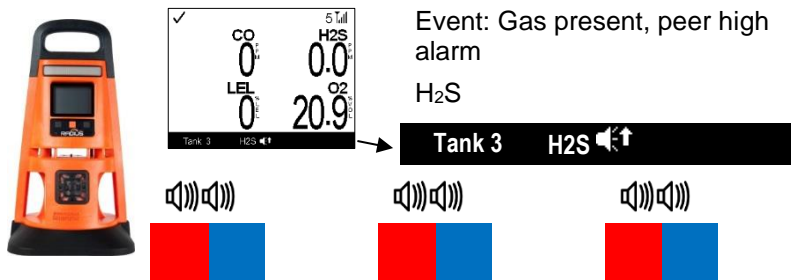

Warnings

Warnings notify workers of a condition that needs attention.

Warnings turn on and off repeatedly. The more urgent the warning, the shorter the time between on-off occurrences: a warning that repeats every ten seconds is more urgent than a warning that repeats every thirty seconds.

When all signals are on, all warnings will be audible. A high-level warning will also emit red and blue light, and a lower-level warning only blue. Compared to alarms, warning signals are emitted at a lower level of intensity.

Warnings persist until the issue is resolved. In some cases, an unresolved warning will cause an alarm. For example, if the low-battery warning turns on and the instrument is not charged, the signals will change from warning status to alarm status (critical low battery).

Note: Signals (visual and audible) vary based on instrument settings.

Group lost^a

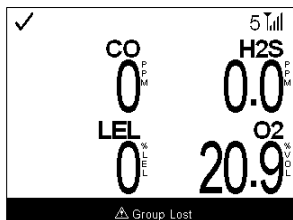

The instrument is no longer a LENS peer-group member.

Sensor failure

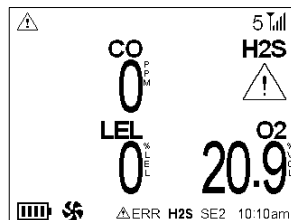

One or more sensors is not working (H₂S shown).

Low battery

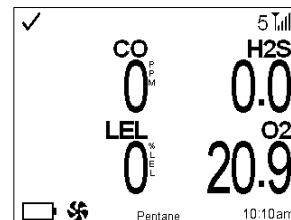

Remaining battery power is low.











Figure 6.6 Example warning display-screens

^aSettings may permit the warning to be turned off by pressing and holding the right or left button.

Indicators

Indicators notify the instrument operator of status and appear as a flash of blue light.

Table 6.1 Warnings and indicators; causes and signal frequency

Symbol	Event type and description	Warning Frequency (seconds)	
		10 s	30 s
 Peer Lost	Peer Lost A peer instrument is no longer communicating with any instruments in the LENS group. The user name displays if there is a current user assignment, otherwise, the peer instrument's serial number displays.	✓	
 Group Lost	Group Lost The instrument is no longer communicating with any instruments in the LENS group.	✓	
	Sensor failure One or more sensors is not working. See the section below on <i>Failures and Errors</i> .	✓	
	LEL-Low O ₂ LEL and O ₂ sensors are installed and the concentration of O ₂ is insufficient for LEL sensor functionality.	✓	
	Low battery When this symbol displays in the navigation bar, it indicates that the Radius Base battery has sufficient power to operate the instrument for at least 30 minutes.		✓
	Instrument data are not reaching iNet or users of iNet Now.	Display-screen symbol only	
Text 	GPS "No GPS Signal  " will display in the navigation bar to indicate the instrument cannot obtain its GPS coordinates. Depending on the instrument's intended application, moving the unit may allow it to acquire a signal in another location. <i>Note:</i> GPS is operational only outdoors.	Display-screen message only	
	Dock due.		✓
	Maintenance due (bump test shown)		✓
No symbol is displayed.	Confidence indicator.	Varies based on setting	

When an instrument is in continuous operation, it will perform a self-test every 12 hours, which may cause a brief, low-volume signal.

Resolving Failures and Errors

When addressing any failure or error, always respond according to your company safety policy. As described below, some of these issues are easily resolved by qualified personnel. For other errors or failures, contact Industrial Scientific.

When a recommended action suggested below requires maintenance or service, complete the work in an area known to be nonhazardous and follow all other instructions provided in "Maintenance" (Chapter 7) or "Service" (Chapter 8).

Table 6.2 Failures and errors

Critical errors

Message

Recommended actions

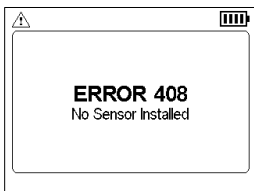

The display screen reproduction shown here is an example of a critical error. Until a critical error is resolved, *the instrument will not be operational*. In this case, Error 408, qualified personnel can check the installed sensors for proper installation, correct location, and compatibility. The numeric error code indicates a specific issue or type of issue. When the error is described on the display screen, qualified personnel can attempt to resolve the issue. If no text accompanies the error code, contact Industrial Scientific or an authorized service center for assistance.

Sensor failures and errors

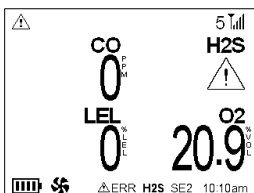

The display screen reproduction shown here is an example of a sensor failure. The failure symbol "⚠" is placed to indicate the sensor in failure and the navigation bar displays a text description of the problem.

Symbols and other display-screen items that are used to describe sensor failures are listed below.

Symbol

Cause

Recommended actions



If the symbol appears *in place of* the gas reading, a non-DualSense sensor is in failure or both sensors in a DualSense pair are in failure. In either case, the instrument is not able to monitor for that gas.

When one sensor in a DualSense pair is operational and one is in failure, the gas reading for the operational sensor displays and the error symbol appears above the reading; the navigation bar provides details about the failure.

Power off the instrument, then power it back on. If the failure persists, check the sensor for proper installation. If needed, replace the sensor.

If the sensor is a *biased* sensor, a sensor error can occur when the SafeCore Module's backup battery does not have sufficient charge to support the biased sensor. Replace the module's backup battery (see chapter 8, "Service").

The sensor pair is no longer operating in DualSense mode for the indicated gas type. Displayed sensor readings for this gas are supplied only by the functional sensor. Respond according to your company safety policy.

Text



"No GPS Signal ⚠" will display in the navigation bar to indicate the instrument cannot obtain its GPS coordinates.

Depending on the instrument's intended application, moving the unit may allow it to acquire a signal in another location. Ensure that the site provides ample, open-sky access and the location is not shielded. *Note:* GPS is operational only outdoors.

ERR

The sensor has a data fault or is not compatible with the installation location.



Check the sensor for proper installation, correct location, and compatibility.

OFF

The sensor's setting is turned off and the sensor is not operational.

Change settings to make the sensor operational.

Table 6.2 Failures and errors

	The sensor failed the zeroing process.	Repeat the zeroing process.
	The sensor failed bump testing.	Calibrate the instrument, then complete a bump test.
	The sensor failed calibration.	<p>Calibration results indicate the sensor's span reserve percentage. When that value is less than 50%, the sensor will not pass calibration and is due for replacement. If the span reserve percentage indicates the sensor is greater than 50% check for the following:</p> <ul style="list-style-type: none"> • Ensure that the calibration cup is compatible with the instrument and is correctly and securely placed in the gas path. • Check the tubing for splits, blockage, or damage. • Ensure that the tubing is secured to the calibration cup and the cylinder's regulator. • Ensure the cylinder is not empty and contains the required gas concentrations. • If needed, repeat the calibration process.

Other failures and errors

Message	Recommended actions
Low Backup battery	The battery in the SafeCore Module can no longer support biased sensors and the clock when the module is uninstalled from the base or docking station. Qualified personnel can replace the battery. <i>Note:</i> Biased sensors require continuous power; after the backup battery is replaced, any installed biased sensors will require stabilization time before they become operational again (see Chapter 1, " <i>Recommended Practices, Biased Sensors</i> ").
Alarms off	The audible and visual alarms have been turned off using settings. See a supervisor to adjust the alarm settings.
Radio voltage error	The power supply for the wireless radio is not working properly.

Maintenance

Overview

Guidelines

Process At-a-glance

Supplies and Preparation

Instruction

Overview

Zeroing, calibration, and bump testing can be completed manually or by docking the SafeCore® Module in a compatible docking station from Industrial Scientific. Instruction is provided below for completing these tasks manually on a diffusion instrument.

Tones emitted from the speaker during maintenance are lower in volume compared to the audible alarm signals. The alarm muffler accessory from Industrial Scientific may be used to further diminish the volume; be sure to remove the muffler before instrument operation.

Guidelines

- Work in an area known to be nonhazardous.
- Use certified Industrial Scientific calibration gas.

Process At-a-glance

Whether bump testing or calibrating manually, the basic steps are:

- Gather the needed supplies.
- Prepare the gas cylinder for use.
- Access the utility on the instrument.
- Connect the calibration cup to the instrument.
- Turn on the gas cylinder.
- View the results.
- Remove the calibration cup.
- *Turn off the gas cylinder.*

Results are indicated by the following symbols.

- | | | | |
|---|--------|----|--------------------------------|
| ✓ | Passed | ▶▶ | Skipped |
| ✗ | Failed | — | Not relevant to the procedure. |

Supplies and Preparation

Use Figure 7.1 as a guide to gathering supplies and preparing the calibration gas cylinders.

Supplies

- Calibration tubing (shipped with the instrument).
- Calibration cup (shipped with diffusion instruments only).
- Calibration gas cylinders suitable for the installed sensors and the instrument's calibration gas settings.
- For a *diffusion* unit, use a *positive-flow* regulator suitable for the calibration gas cylinder and for an *aspirated* unit, a *demand-flow* regulator.

Preparation



Holding the regulator (positive flow shown), turn the calibration gas cylinder in a clockwise direction to tighten.



Connect one end of the calibration tubing to the regulator's nipple.

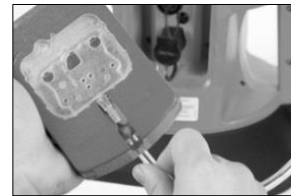

For diffusion units (shown), connect the other end of the tubing to the calibration cup.

Proceed with the instruction set below for the desired task, zeroing, calibration or bump test.

Figure 7.1 Maintenance supplies and preparation

Instructions

Figure 7.2.A through 7.2.C provide maintenance instructions for: zeroing, calibration, and bump testing.

Zeroing utility

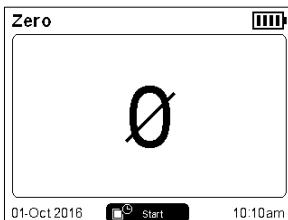

+ Hold
Start the utility

Zeroing progress

S#	Sen	Results
1	CO	0 PPM
2	H2S	00 PPM
3	LEL	ERR
4	--	--
5	O2	138 %
6	--	--

Optionally skip zeroing

Zeroing results

S#	Sen	Results
1	CO	0 PPM ✓
2	H2S	00 PPM ✓
3	LEL	ERR →
4	--	--
5	O2	20.9 %VOL ✓
6	--	--

If all sensors passed, calibration starts. If any sensor failed, zeroing repeats.

Figure 7.2.A Zeroing instructions

Calibration cup



For diffusion units (shown), slide the prepared calibration cup into the gas path. Press firmly; verify that the calibration cup edge is flush with the surface of the SafeCore Module.
For aspirated units, connect the calibration tubing to the pump inlet.

Calibration apply gas

Calibration			
S#	Sen	Gas	Results
1	CO	100 PPM	
2	H2S	25.0 PPM	◀ Apply Gas
3	LEL	ERR	
4	—		
5	O2	20.9 %VOL	138 % ✓
6	—		

01-Oct-2016 SKIP ▶▶ 10:10am



Optionally skip the sensor.
Apply calibration gas of the type and concentration stated on the instrument's display screen and indicated by the symbol ◀.
Aspirated units can draw the gas as needed from a demand flow regulator.

To start the flow of gas, turn the regulator's knob in a counterclockwise direction.
Continue to follow the display-screen prompts to apply the requested calibration gas. At each prompt, if the gas is not sensed, the instrument will wait up to five minutes to accommodate a change of gas cylinders.

Calibration results

Calibration			
S#	Sen	Gas	Results
1	CO	100 PPM	187 % ✓
2	H2S	25.0 PPM	184 % ✓
3	LEL	ERR	Skipped ▶▶
4	—		
5	O2	20.9 %VOL	138 % ✓
6	—		

01-Oct-2016 ◀ 10:10am

End



■ End ■
If needed, repeat for any failed sensor If needed, repeat for any failed sensor

Remove the calibration cup from the gas path: slide it away from the instrument and set aside or store for future use.
For aspirated units, simply disconnect the tubing from the pump inlet.

Stop the flow of gas: turn the regulator knob in a clockwise direction and tighten

Figure 7.2.B Calibration instructions

Calibration cup



For diffusion units (shown), slide the prepared calibration cup into the gas path. Press firmly; verify that the calibration cup edge is flush with the surface of the SafeCore Module.

For aspirated units, omit the calibration cup and simply connect the calibration tubing to the pump inlet.

Bump test utility

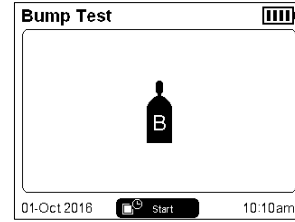

+ Hold

Start the utility

Bump test apply gas

S#	Sen	Gas	Results
1	CO	100 PPM	
2	H2S	25.0 PPM	
3	LEL	ERR	
4	—	—	
5	O2	19.0 %VOL → 20.9 %VOL	
6	—	—	

01-Oct-2016 **SKIP** 10:10am



Bump test results

S#	Sen	Gas	Results
1	CO	100 PPM	100 PPM ✓
2	H2S	25.0 PPM	24.9 PPM ✓
3	LEL	ERR	Skipped ▶▶
4	—	—	
5	O2	19.0 %VOL	17.2 %VOL ✓
6	—	—	

01-Oct-2016 **←** 10:10am



Optionally skip the sensor

Apply gas of the type and concentration stated on the instrument's display screen and indicated by the symbol ▶.

To start the flow of gas, turn the regulator's knob in a counterclockwise direction. Continue to follow the display-screen prompts to apply the requested calibration gas. At each prompt, if the gas is not sensed, the instrument will wait up to five minutes to accommodate a change of gas cylinders.

Aspirated units can draw the gas as needed from a demand flow regulator.



If needed, repeat for any failed sensor



End



If needed, repeat for any failed sensor

The instrument's display screen will state the bump test results for all installed sensors.

End



Remove the calibration cup from the gas path: slide it away from the instrument and set it aside or store it for future use.

For aspirated units, simply disconnect the tubing from the pump inlet.

Stop the flow of gas: turn the regulator knob in a clockwise direction and tighten

Figure 7.2.C Bump test instructions

Service and Warranty

Service

Warranty

Service

Service tasks that can be completed by Industrial Scientific customers are described in this manual. Table 8.1 indicates which parts and components are customer replaceable. All other service tasks should be performed only by Industrial Scientific or an authorized service center.

Guidelines

Use the following guidelines when servicing the Radius® BZ1 Area Monitor.

- Service tasks should be performed only by qualified personnel.
- Use only approved Industrial Scientific parts and accessories.
- Perform service tasks in a nonhazardous location.
- Work on a nonconductive surface in a well-lit area.
- Wear grounding straps to prevent electrostatic discharge (ESD), which can cause damage to the instrument's electronics.
- To support ingress protection, refer to Table 8.1 and apply the stated torque values. If a settable torque driver is not available, hand tighten the screws; do not overtighten.
- Before removing the SafeCore® Module's battery, dock the instrument to synchronize it with iNet® or DSSAC, if applicable.

Use care when working with the adhesive-backed filters and barriers.

- Avoid touching these items as much as possible. Tweezers used with gentle pressure can be helpful.
- Be careful not to pierce or tear these items.
- Once the adhesive touches a surface, any attempt to remove or reposition the item may damage it.

Use care when working with sensors and barriers.

- Avoid touching the top of any sensor as this can contaminate or damage a sensor.

Supplies

- ✓ Screwdriver set from Industrial Scientific (includes T30 and T10 torx bits)
- ✓ T20 torx bit for boot replacement (supplied with replacement boot kit only)
- ✓ Needle-nose tweezers

Instruction

Figure 8.1 provides disassembled views of the instrument, the Radius Base and SafeCore Module, identifying their parts and components. Use Table 8.1 to determine which items are customer replaceable and identify their part names and part numbers.

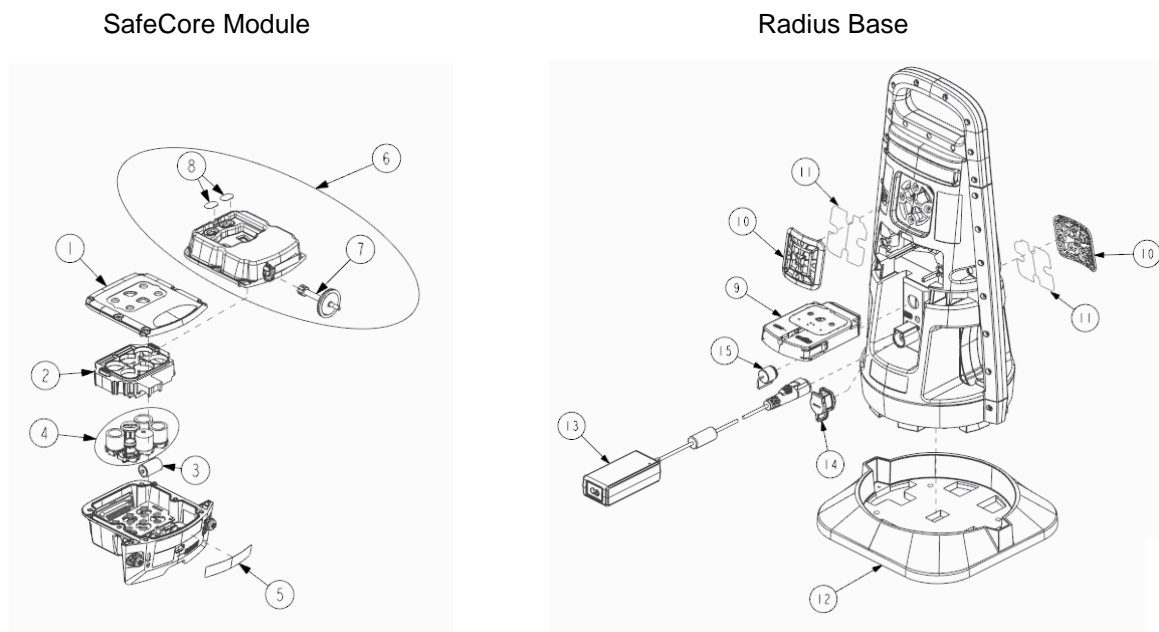

Figure 8.1 Parts diagram for SafeCore Module and Radius Base

Table 8.1 Parts table for SafeCore Module and Radius Base

Diagram no.	Part name	Part number	Notes
SafeCore Module			
1	Diffusion module cover	18109446	Includes cover, dust filter, water barrier, and screws. Torque: 0.88 newton m (125 ounce-force inch).
6	Aspirated assembly and module cover	18109507	Includes pump, cover, dust filters, water barrier, and screws. Torque: 0.88 newton m (125 ounce-force inch).
2	Sensor collar	17155888	
3	Lithium Thionyl Chloride (Li-SOCl ₂)	17156465	Clock battery.
4	Sensors	Varies	See Figure 2.2 for compatible sensors and their part numbers.
5	SafeCore nameplate	17156771	—
—	SafeCore module screw kit	18109615	Secures module to base.
—	Hand tool	17156983	Screwdriver set includes T30 and T10 torx bits.
7	Aspirated inlet water barrier	18109455	Pack of 3.
8	Aspirated dust filter	18109447	Pack of 2.

Table 8.1 Parts table for SafeCore Module and Radius Base

Diagram no.	Part name	Part number	Notes
—	Sensor plug	17134701	—
Radius Base			
—	Radius Base	Varies	Base without SafeCore Module.
9	Calibration cup and tubing kit	18109498	
10	Speaker grill kit	18109444	Includes speaker grill and replacement screws. Torque: 0.81 newton m (115 ounce-force inch).
11	Speaker dust filter	18109445	Pack of 2.
12	Boot	18109448	Includes replacement boot and T20 torx bit for use with screwdriver set. Torque: 1.4 newton m (200 ounce-force inch).
13	Charging power supply	17155923	Power cord ordered separately.
—	Power cord (NA)	17155000	1715500, 17155001, 17155003, and 17155505 are for use with the charging power supply (17155923).
—	Power cord (EU)	17155003	
—	Power cord (AUS)	17155001	
—	Power cord (UK)	17155005	
14	Charging port cap	17155934	—
15	Intrinsic safety cable port cap	17155932	—
—	IS cables	varies	See Table 2.2 Compatible power supplies for part numbers, cable length, and cable–power supply compatibility
—	Alarm muffler	18109442	Pack of 2.

 *Power off the instrument before disassembling or performing any service task.*

Speaker grill and dust barrier service

Speaker grill removal



Use the supplied screwdriver set to remove all four speaker-grill screws. Set aside the screws.



Holding the edge of the grill, pull it away from the Radius Base. Set aside the grill.

Speaker dust barrier replacement (if needed)



Peel off the dust barrier and discard.



Remove any remnants of the adhesive. Clear away any dirt, dust, or debris.



Separate the new dust barrier from its backing.



Guide the new barrier—adhesive side down—onto the case top. For proper placement, ensure that the notched barrier edges meet the notched edges of the filter opening.

Speaker grill replacement (or reattachment)



Press gently along the barrier edges to support adhesion.



Place the speaker grill over the dust filter.



Screw in the four speaker-grill screws. Refer to Table 8.1 for torque value.

Pump inlet water barrier replacement



Hold the water barrier at the connector. Turn it counterclockwise and pull to remove it.



Align the replacement water barrier with the air inlet; turn clockwise to tighten.

Port cap replacement (charging port cap shown)



Open the charging port by removing its cap.



Gently pull on the cap to detach it from the instrument.



To attach the replacement port cap, place its loop around the port's casing.

Boot replacement

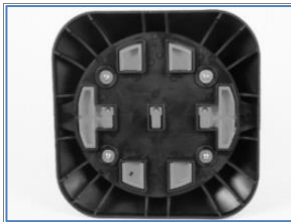

Carefully place the instrument face down. To prevent damage to the instrument, ensure there is ample, clear space on the work surface beneath it.

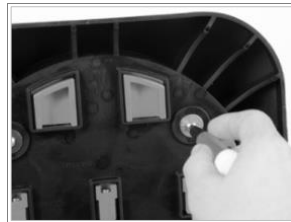

Using the screwdriver set and the T20 torx bit that shipped with the new boot, remove and discard the screws that secure the boot to the Radius Base.

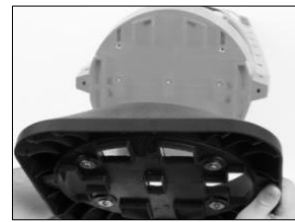

Pull the boot to remove it.

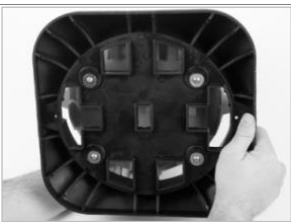

Align the screw holes and place the new boot on the bottom of the Radius Base.

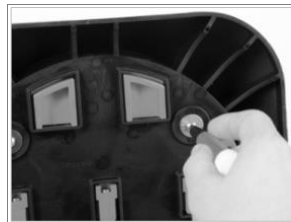

Tighten the screws; refer to Table 8.1 for torque value.

Figure 8.2 Service tasks, Radius Base

 *Power off the instrument before disassembling or performing any service task.*

Module removal



Use the supplied screwdriver set to loosen the two locking, captive screws on the back of the SafeCore Module. To remove and replace the screws, use the SafeCore module screw kit.



To remove the module from its port, pull it straight away from the base. Use care not to damage the module's connector pins.

Module disassembly



Turn the module upside down to access the cover.

Using the screwdriver set, remove the six screws; set them aside for later reassembly.



Gently separate the cover from the SafeCore base.

For an aspirated unit (right), disconnect the connector from its pins by pinching the connector's locking prong and lifting the connector.

Store the used cover for later reuse; otherwise, set it aside for module assembly.



Hold the sensor collar by the edges. Lift it straight up to remove it; set aside the collar for later reassembly.

Notes: After module reassembly, calibrate the instrument for any newly installed sensors. Any newly installed biased sensors may require stabilization time before they become operational.

Sensor replacement

 *Do not touch the top of any sensor as this can contaminate or damage the item.*



Firmly hold the sides of the sensor, then pull it straight up and away from the circuit board.

Set aside the sensor for future use or dispose of according to company policy.



Position the new sensor to align with its connectors on the circuit board.



Place the sensor on the circuit board. Apply gentle pressure to the rim of the sensor housing. When installed correctly, there will be an audible click when each sensor connector is secured to the circuit board.

Sensor dust barrier replacement



Using your fingers or needle-nose tweezers, peel off the used dust barrier and discard.

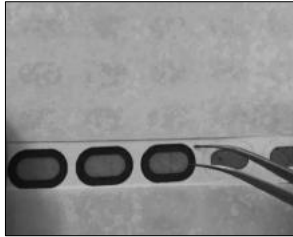

Place the sheet on the work surface and scrape lightly to the barrier's edge. Gently lift to expose a portion of its adhesive back. Peel the barrier from the sheet. Guide the new filter into place—adhesive side down. Press and hold to support adhesion.

Battery replacement



Lift the battery away from the unit. Dispose of the battery according to company policy.

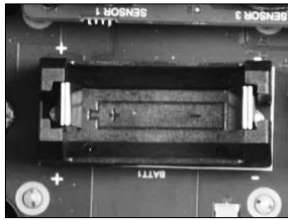

Align the new battery with the polarity markers inside the SafeCore Module. Firmly press the new battery into place.



Note: When the battery is removed from the SafeCore Module or becomes completely discharged, the time and date settings are lost. The instrument operator will be prompted to set the date and time the next time the unit is powered on. These settings can be updated manually or by docking the module.

Module assembly



Hold the sensor collar by the edges. Align and lower the collar into the module.

Press down on the collar; the fit should be snug around the sensors.

For each installed sensor, apply gentle pressure to the sensor rim only. This will help secure any sensor that might not be completely connected to the circuit board.

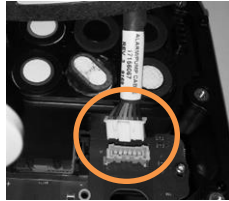

aspirated

To reattach (or replace) the aspirated assembly and module cover, plug the module's connector into its pins; the locking prong aligns with the front of the module and will click when correctly inserted.

Hold the cover by the edges and align it with the module; then, lower it onto the module.



diffusion



Using the screwdriver set, insert and tighten the six module-cover screws. Refer to Table 8.1 for torque value.

Module installation



Visually inspect the SafeCore Module connector (circled) for dirt and debris. Clean with compressed air as needed.



With the SafeCore logo facing towards you and right-side up, slide the module straight into its port. Push firmly to connect the module to the base. Use care not to damage the module's connector pins.

When installed correctly, there will be slight connection impact and the module edge will be flush with the base.



Using the supplied screwdriver set, tighten both module screws. Push the screw into the borehole; its spring will compress. Turn the screw clockwise; tighten until the red indicator surrounding the borehole is no longer visible.

Figure 8.3 Service tasks, SafeCore Module

Warranty

Industrial Scientific Corporation's Radius® BZ1 Area Monitors are warranted to be free from defects in material and workmanship under normal and proper use and service for twenty-four (24) months from date of shipment. This warranty includes sensors, batteries, and internal pumps, except where otherwise stated in writing in Industrial Scientific literature accompanying the product.

Limitation of Liability

THE WARRANTY SET FORTH ABOVE IS STRICTLY LIMITED TO ITS TERMS AND IS IN LIEU OF ALL OTHER WARRANTIES, GUARANTEES, EXPRESS OR IMPLIED, ARISING BY OPERATION OF LAW, COURSE OF DEALING, USAGE OF TRADE OR OTHERWISE. INDUSTRIAL SCIENTIFIC MAKES NO OTHER WARRANTIES, EITHER EXPRESSED OR IMPLIED, INCLUDING BUT NOT LIMITED TO THE WARRANTIES OF MERCHANTABILITY OR FITNESS FOR PARTICULAR PURPOSE.

SHOULD THE PRODUCT FAIL TO CONFORM TO THE ABOVE WARRANTY, BUYER'S ONLY REMEDY AND INDUSTRIAL SCIENTIFIC'S ONLY OBLIGATION SHALL BE, AT INDUSTRIAL SCIENTIFIC'S SOLE OPTION, REPLACEMENT OR REPAIR OF SUCH NON-CONFORMING GOODS OR REFUND OF THE ORIGINAL PURCHASE PRICE OF THE NONCONFORMING GOODS.

IN NO EVENT WILL INDUSTRIAL SCIENTIFIC BE LIABLE FOR ANY OTHER SPECIAL, INCIDENTAL, CONSEQUENTIAL, PUNITIVE OR OTHER SIMILAR DAMAGES, INCLUDING LOSS OF PROFIT OR LOSS OF USE, ARISING OUT OF THE SALE, MANUFACTURE OR USE OF ANY PRODUCTS SOLD HEREUNDER WHETHER SUCH CLAIM IS PLEADED IN CONTRACT OR IN TORT, INCLUDING STRICT LIABILITY IN TORT AND WHETHER INDUSTRIAL SCIENTIFIC HAS BEEN ADVISED OF THE POTENTIAL FOR SUCH DAMAGES. Industrial Scientific's total liability hereunder from any cause whatsoever (except liability from personal injury caused by Industrial Scientific's negligence), whether arising under contract, warranty, tort (including negligence), strict liability, products liability or any other theory of liability, will be limited to the lesser of Buyer's actual damages or the price paid to Industrial Scientific for the Products that are the subject of Buyer's claim. All claims against Industrial Scientific must be brought within one year after the cause of action arises, and Buyer expressly waives any longer statute of limitations.

It shall be an express condition to Industrial Scientific's warranty that all products be carefully inspected for damage by Buyer upon receipt, be properly calibrated for Buyer's particular use, and be used, repaired, and maintained in strict accordance with the instructions set forth in Industrial Scientific's product literature. Repair or maintenance by non-qualified personnel will invalidate the warranty, as will the use of non-approved consumables or spare parts. As with any other sophisticated product, it is essential and a condition of Industrial Scientific's warranty that all personnel using the products be fully acquainted with their use, capabilities and limitations as set forth in the applicable product literature.

Buyer acknowledges that it alone has determined the intended purpose and suitability of the goods purchased. It is expressly agreed by the parties that any technical or other advice given by Industrial Scientific with respect to the use of the goods or services is given without charge and at Buyer's risk; therefore, Industrial Scientific assumes no obligations or liability for the advice given or results obtained.

Appendix A

Supplemental Information about Gases and Sensors

Cross Sensitivity and Toxic Gases

A sensor is designed to detect for and measure the presence of a particular gas, the "target gas"; however, it may also respond to other gases. When this is the case, the sensor is said to have "cross-sensitivity" to another gas, which will interfere with the target-gas readings. Table A.1 provides insight to the levels of cross sensitivity that can exist and whether a nontarget gas will have the effect of adding to or subtracting from the target-gas readings.

For example, a site is being monitored for H₂S; the air also contains NO₂. According to table A.1, the H₂S sensor will respond to NO₂, so the H₂S readings will account for both gases. Because the NO₂ cross-sensitivity value is negative (-25%), its presence will *subtract from* the H₂S readings, which will generate an H₂S reading that is *lower* than the actual concentration of H₂S that is contained in the air sample.

When a cross-sensitivity value is positive, the opposite will happen. When a gas has a positive cross-sensitivity value, it will add to a sensor's target gas reading, which will generate a reading that is higher than the actual concentration of the target gas that is contained in the air sample.

Table A.1 Cross-sensitivity guidelines (%)

Target Gas	Sensor						
	CO	CO/H ₂ Low	H ₂ S	SO ₂	NO ₂	HCN	NH ₃
CO	100	100	1	1	0	0	0
H ₂ S	5	5	100	1	-40	10	25
SO ₂	0	5	5	100	0	—	-40
NO ₂	-5	5	-25	-165	100	-70	-10
Cl ₂	-10	0	-20	-25	10	-20	-50
ClO ₂	—	—	—	—	—	—	—
HCN	15	—	—	50	1	100	5
HCl	3	—	—	5	0	0	0
PH ₃	—	—	—	—	—	425	—
NO	25	40	-0.2	1	5	-5	0
H ₂	22	3	0.08	0.5	0	0	0
NH ₃	0	0	0	0	0	0	100

The values supplied above are estimates. They generally apply only to new sensors used for monitoring gases in these environmental conditions: 20 °C (68 °F), 50% RH, and 1 atm. Values are subject to change.

"—" indicates no available data.

LEL and Combustible Gases

Table A.2 provides the Lower Explosive Limit (LEL) for select combustible gases. It also provides correlation factors that can help determine the percentage LEL when the actual gas differs from the gas that was used to calibrate the instrument.

For example, if the instrument reads 10% LEL in a pentane atmosphere, and was calibrated to methane, the actual percentage LEL is determined as follows:

1. Locate the table cell where the sample gas (pentane) intersects with the calibration gas (methane).
2. Multiply the cell's value (2.02) by the instrument's LEL reading (10%) to calculate the actual concentration of 20.2% LEL.

Table A.2 LEL correlation factors

Sample gas	LEL (% vol)	Calibration gas					
		Butane	Hexane	Hydrogen	Methane	Pentane	Propane
Acetone	2.5%	1.00	0.70	1.70	1.70	0.90	1.10
Acetylene	2.5%	0.70	0.60	1.30	1.30	0.70	0.80
Benzene	1.2%	1.10	0.80	1.90	1.90	1.00	1.20
Butane	1.9%	1.00	0.58	1.78	1.67	0.83	1.03
Ethane	3.0%	0.80	0.60	1.30	1.30	0.70	0.80
Ethanol	3.3%	0.89	0.52	1.59	1.49	0.74	0.92
Ethylene	2.7%	0.80	0.60	1.40	1.30	0.70	0.90
Hexane	1.1%	1.71	1.00	3.04	2.86	1.42	1.77
Hydrogen	4.0%	0.56	0.33	1.00	0.94	0.47	0.58
Isopropanol	2.0%	1.10	0.90	2.00	1.90	1.00	1.20
Methane	5.0%	0.60	0.35	1.06	1.00	0.50	0.62
Methanol	6.0%	0.60	0.50	1.10	1.10	0.60	0.70
Nonane	0.8%	2.22	1.30	3.95	3.71	1.84	2.29
Pentane	1.4%	1.21	0.71	2.15	2.02	1.00	1.25
Propane	2.1%	0.97	0.57	1.72	1.62	0.80	1.00
Styrene	0.9%	1.30	1.00	2.20	2.20	1.10	1.40
Toluene	1.1%	1.53	0.89	2.71	2.55	1.26	1.57
Xylene	1.1%	1.50	1.10	2.60	2.50	1.30	1.60
JP-4	—	—	—	—	—	1.20	—
JP-5	—	—	—	—	—	0.90	—
JP-8	—	—	—	—	—	1.50	—

Note: LEL correlation-factor accuracy may change without notice and is impacted by exposure to sensor inhibitors or poisons, sensor aging, the gas-detection applications and environment, and other factors. Calibrate instruments using the intended target gas when feasible and validate correlation factors as needed.

Appendix B

Extended Run Time Power Supply (ERTPS)—supplemental information

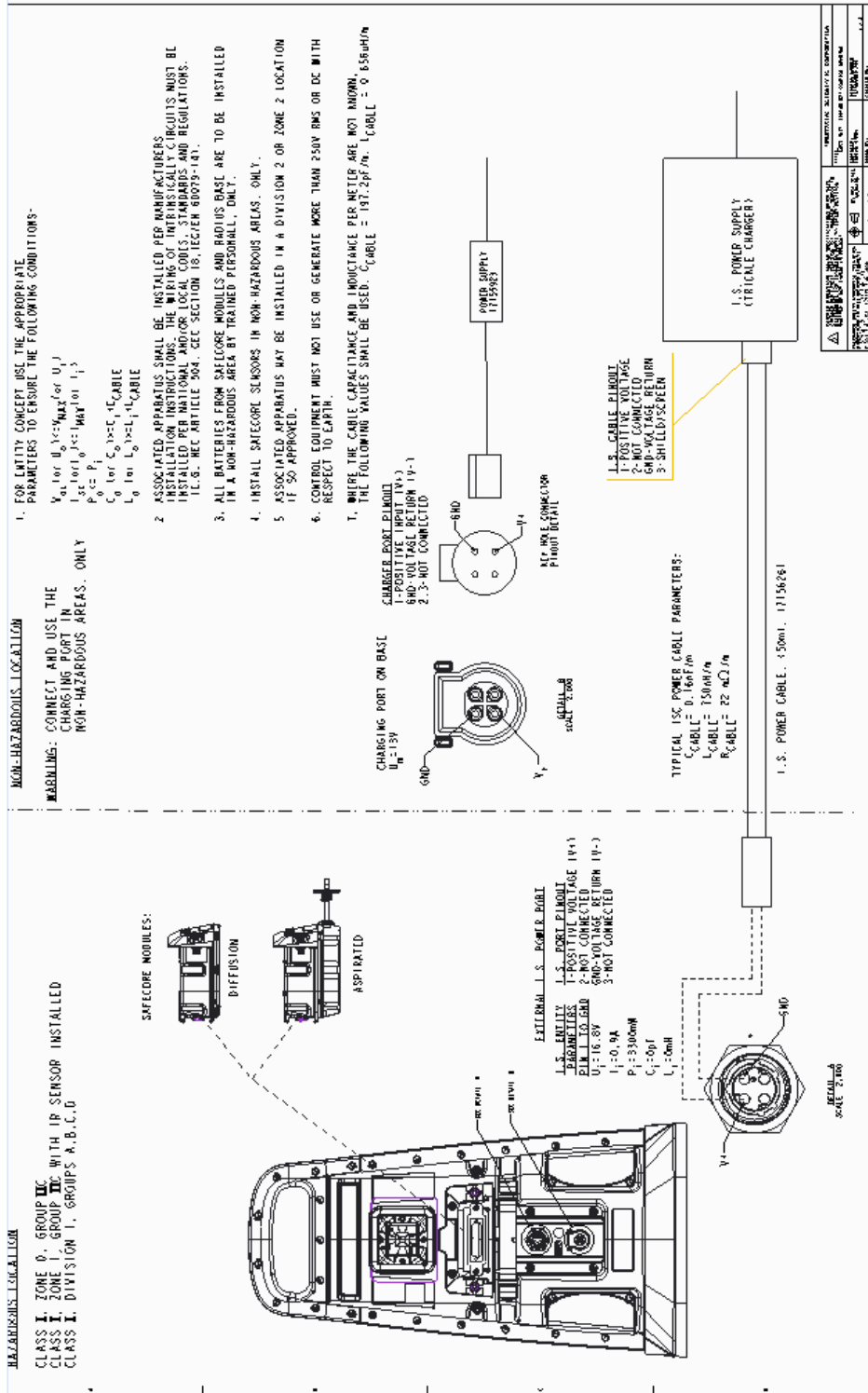

Figure B.1 Control drawing 1810D9387-200 revision 3

Appendix C

Intrinsically Safe Extended Run Time Power Supply (ISERTPS)—supplemental information

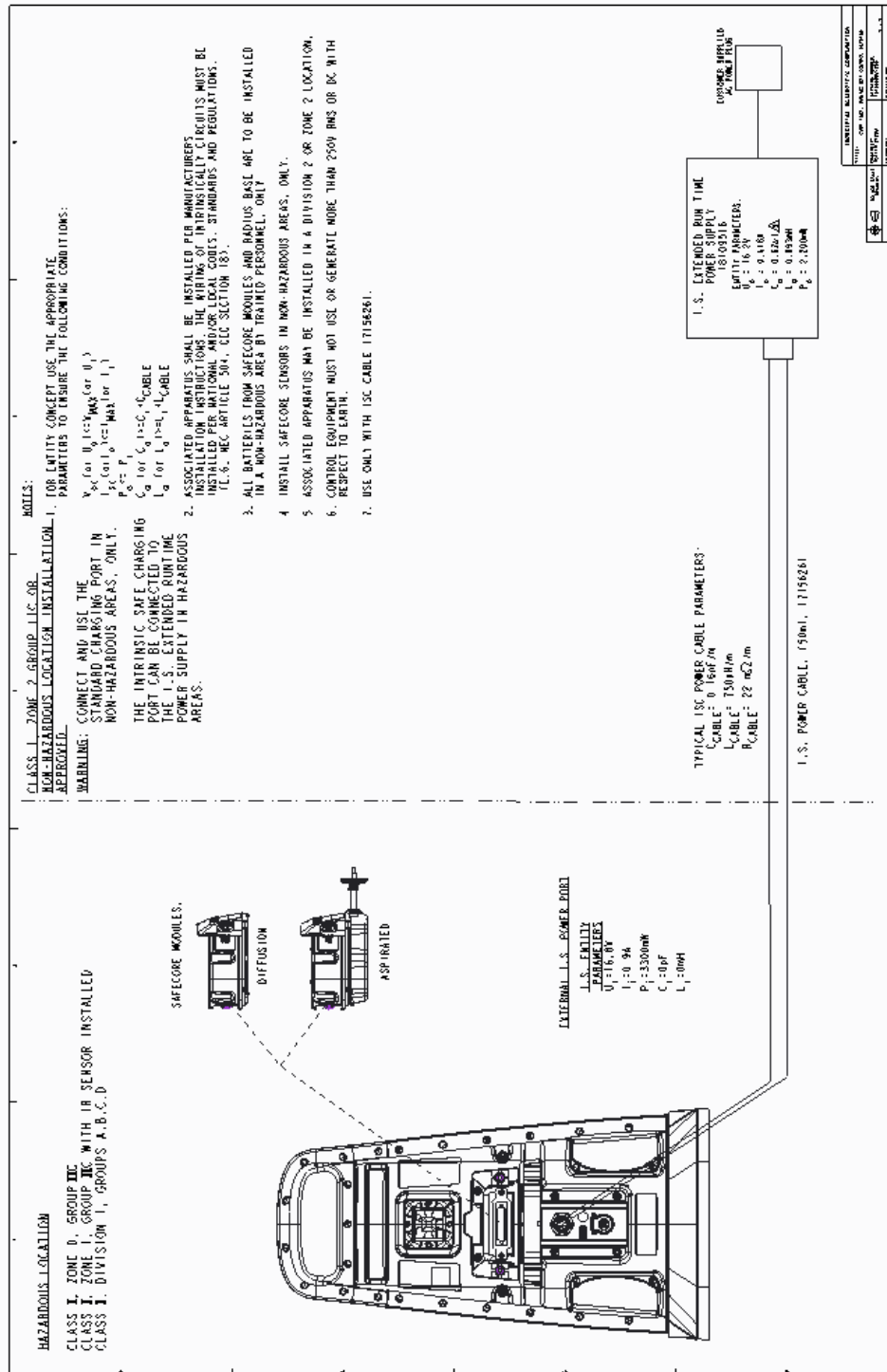

Figure C.1 Control drawing 1810D9387-200 revision 3

Contact Information

Industrial Scientific Corporation

1 Life Way
Pittsburgh, PA 15205-7500 USA
Web: www.indsci.com
Phone: +1 412-788-4353 or 1-800-DETECTS (338-3287)
E-mail: info@indsci.com
Fax: +1 412-788-8353

Industrial Scientific France S.A.S.

11D Rue Willy Brandt
62002 Arras Cedex, France
Web: www.indsci.com
Téléphone : +33 (0)1 57 32 92 61
E-mail: info@eu.indsci.com
Fax: +33 (0)1 57 32 92 67

英思科传感仪器（上海）有限公司

地址：中国上海市浦东金桥出口加工区桂桥路290号
邮编：201206
电话：+86 21 5899 3279
传真：+86 21 5899 3280
E-mail： iscapinfogroup@indsci.com
网址： www.indsci.com
服务热线：+86 400 820 2515

To locate a nearby distributor of our products or an Industrial Scientific service center or business office, visit us at www.indsci.com.

Rendez-vous sur notre site Web www.indsci.com, si vous voulez trouver un distributeur de nos produits près de chez vous, ou, si vous recherchez un centre de service ou un bureau Industrial Scientific.

Besuchen Sie uns unter www.indsci.com, um einen Vertriebshändler unserer Produkte oder ein Servicecenter bzw. eine Niederlassung von Industrial Scientific zu finden.

Para buscar un distribuidor local de nuestros productos o un centro de servicio u oficina comercial de Industrial Scientific, visite www.indsci.com.

如需查找就近的产品经销商或 Industrial Scientific 服务中心或业务办事处，请访问我们的网站 www.indsci.com

INDUSTRIAL
SCIENTIFIC